

Enclosed Conductor Rail

BoxLine Program 0842

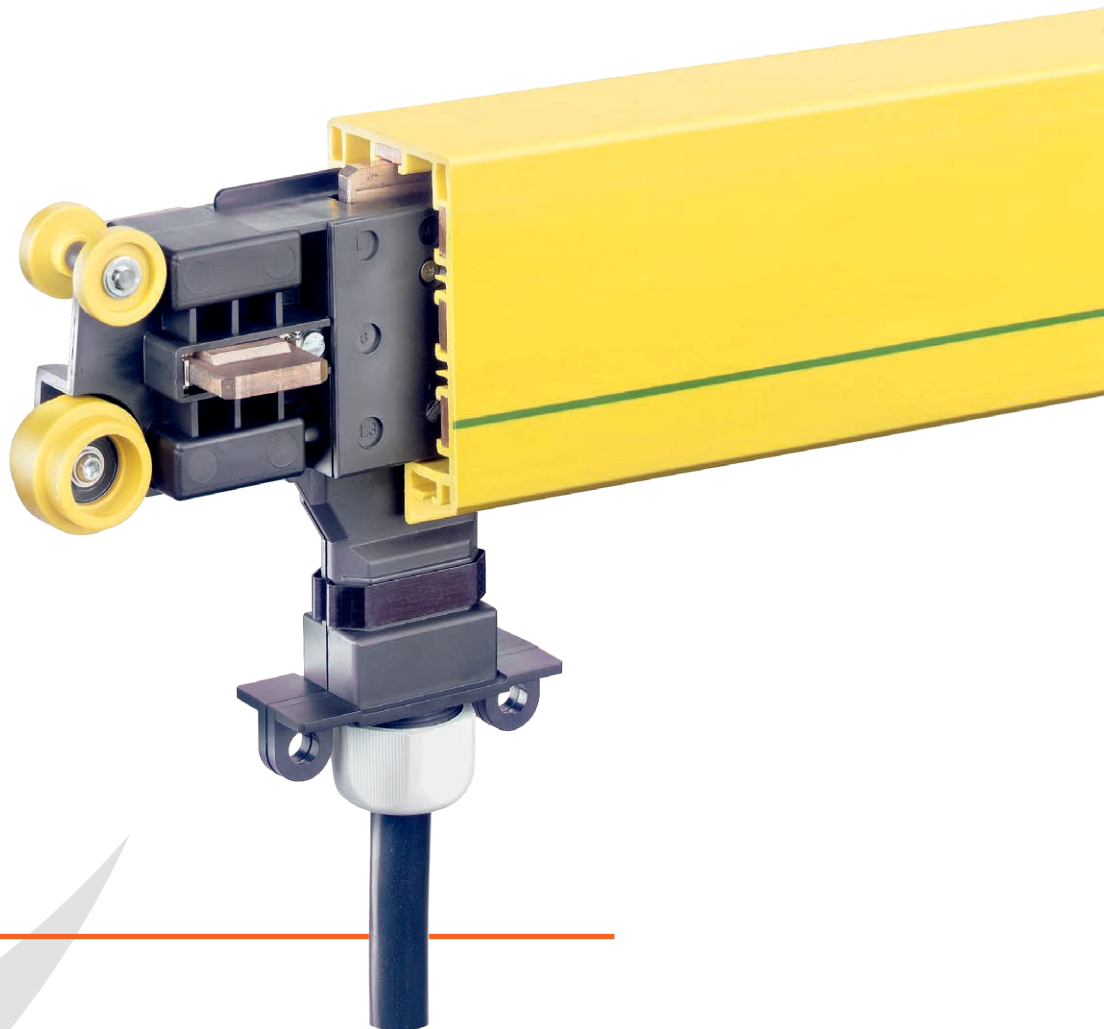

CONDUCTIX
wampfler

General Hints

We reserve the right to carry out any modification of the product at any time in the course of technical progress without prior notice. All our equipment is in accordance with CE. Our general terms of business are effective. We shall send them to you on request. Reprint, even of extracts, is only permitted with our approval.

Contents

Description	
Enclosed Conductor Rails Program 0842 BoxLine	2
The Advantages	2
The System Components	2
Connection Alternatives	3
Technical Data Enclosed Conductor Rails Program 0842 BoxLine	4
Enclosed Conductor Rail System PL (Plug-in Type, 4 Poles)	5
Order Example for a Simple Complete System	5
Conductor Rails and Joint Covers	
System CS (Continuous Strip) and System PL (Plug-in Type)	6
System JT (Joint Clamping) and System AN (Angle Clamping)	7
Rail Curves	
Horizontal Curves	8
Vertical Curves	8
Order Number Code for Curve, System AN (Angle Clamping)	8
Hanger Clamps and Anchor Clamps	
Hanger Clamp	10
Anchor Clamp	10
Hanger Clamp for Higher Temperature Range	10
End Feeds and End Caps	
End Feed up to 60 A for CS (Continuous Strip), PL (Plug-in Type) and AN (Angle Clamping)	11
End Feed up to 100 A for CS (Continuous Strip) and up to 140 A for JT (Joint Clamping)	11
End Cap	11
In-line Feeds	
In-line Feeds with Single Core Cable Entry up to 60 A and In-line Feeds Joint Covers AN (Angel Clamping)	12
In-line Feeds with Terminal Box up to 140 A	13
Expansion Elements	
General Expansion Element Data	14
Example: Setting the Expansion Element Depending on the Temperature	14
Expansion Elements (with 100 mm Expansion) for System CS (Continuous Strip)	15
Expansion Elements (with 100 mm Expansion) for the Systems PL, JT and AN	15
Pick-up Guides	
Pick-up Guides for Transfer Points	16
Conversion Retrofit Kits to Add a Power Feed Point to Pick-up Guides/Transfer Points	16
Pick-up Guides for Entrance Points	17
Pick-up Working Range	17
Collectors and Accessories	
Collector with Connection Cable	18
Double Collector	18
Collector up to 7 Poles; with Single Cores in a Flexible Conduit	19
Towing Arm	19
Wear Parts and Accessories	
Sealing Lip	21
Reinforcing Bracket for Plastic Housing and Storm Safety Device	21
Conversion Retrofit Kits to Add a Power Feed Point to Pick-up Guides/Transfer Points	21
Half Shells	21
Collectors Shoes for Collectors	21
Assembly Tools	
Strip Insertion Trolley for System CS (Continuous Strip)	22
De-coil Unit for Simplified Strip Insertion - Optional (System CS)	22
Bending Device for Chamfering the Copper Strip for System AN (Angle Clamping)	22
Positioning Block for System AN (Angle Clamping) and Insertion Tool for Sealing Lip	22
Support Arm (Optional), Girder Clip (Optional) and Weld-on Bracket for Support Arm (Optional)	23
Program Overview	
Conductor Rails	24
General Hints	24

Description

Enclosed Conductor Rails Program 0842 BoxLine

The conductor rail program 0842 completes the Conductix-Wampfler product line of conductor rails by an enclosed conductor rail system for indoor and outdoor use.

The established, universally applicable system is used on crane systems, transfer carriages, tasksaver systems, electric hoisting equipment, theater applications and a variety of other mobile consumers for indoor and outdoor use, ideally suited for straight tracks.

The Advantages

The system 0842 is mainly characterized by the following features:

- Enclosed profile with captured collector
- Collector cable exits the system from the lower slot
- High variability by 4 different types of system connection
- Fast and safe assembly by adjustable and rotating snap-in hanger clamps and other innovative details
- Supplied in easy to handle 4 m sections
- High protection against direct contact and compliance with international standards
- Broad selection of accessories

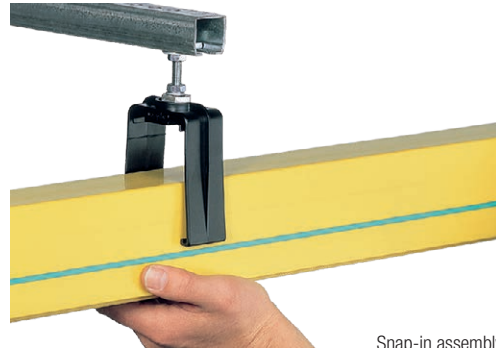

Snap-in assembly

The System Components

Conductor Rails

The conductive strips made of copper or datametal are fastened in high-quality plastic insulating profiles and are available with 4, 5 and 7 poles with a nominal current of 35 to 140 A.

Standard profile lengths of 4000 mm allow a simple application and fast progress in the assembly.

Shorter lengths are available on inquiry.

Devices for optional sealing lips, a guiding notch for the defined introduction of the collector trolley and the integrated PE-identification complement the profile.

Hanger clamp

- Plug-in type: System PL to plug-in up to 60 A
- Angle clamping: system AN screwable up to 60 A
- Joint clamping: system JT screwable up to 140 A

As an alternative to the above solutions, the continuous strip version: system CS is available to eliminate connection points (available up to 100 Amps). A combination of the systems CS and AN allows an easy changeover between the segments, as on a combination with curves.



Suspension

Swivelling and adjustable snap-in hanger clamps allow for the fast, safe and optimized one-man assembly of the rail segments.

Power feed points are available as end feed and center feed. Moreover it is possible to use transfer segments as feedings with the application of a conversion kit.

Expansion Element

Changes in ambient temperature coupled with normal electrical heating of the conductors causes linear expansion. Expansion Elements are used for the absorption of this expansion. The number of required Expansion elements is determined by difference in temperature and the system or segment length. Additional power feeding or additional power feeds are not required when using Expansion elements as the continuity of the system is not interrupted.

Entrance and transfer segments

For isolation or disconnection points within the conductor rail system (i.e. for the isolation of a section of a line), pick-up guides are used for the entry and exit of the collector.

Collector trolley

The roller-guide collector trolleys are available as 4, 5 and 7 pole types. Copper graphite carbon shoes are used for energy and control voltages over 35 V. For the data transmission and low voltage below 35 V we recommend silver graphite carbons in connection with a datametal conductor. Double collectors are used to improve the quality of the contact and for transfers (for further information refer to the collector section).

Towing arm

Towing arms are designed as the attachment point between the moving machine and the collector. They are available in „fork“ or chain versions, both of which are designed for straight, uninterrupted tracks or a special spring-loaded design is available for systems with pick-up guides/isolation sections.

Description

Connection Alternatives

High flexibility by various techniques for joining parts for each required system.

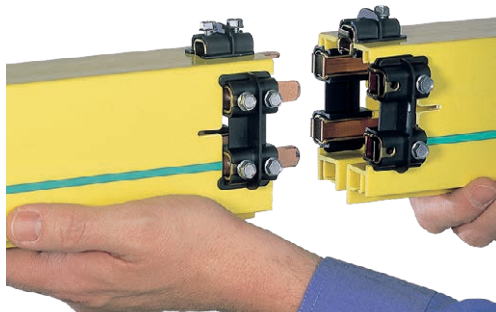

System PL (plug-in type)

Plug-in type (system PL)

Characteristics:

- Simple plug-in
- Ideal for short systems
- From 35 A up to 60 A (100% ED)

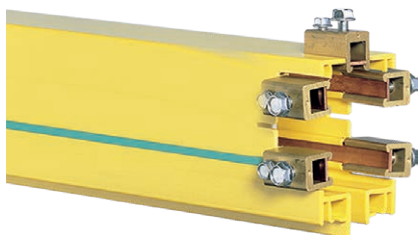

System JT (joint clamping)

Joint clamping type (system JT)

Characteristics:

- Fast joining
- Designed for large cross sections
- From 100 A up to 140 A (100% ED)

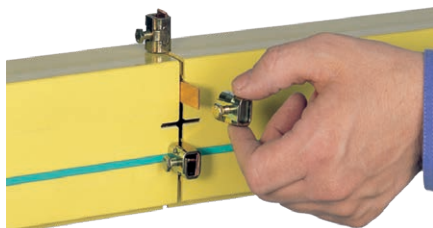

System AN (angle clamping)

Angle clamping type (system AN)

Characteristics:

- Quick flexible solution
- Can be combined with continuous strip version
- From 35 A up to 60 A (100% ED)
- Installation tools, please see page 22

Note

For adding the profile joints, it is required to use a positioning tool (see page 22). This tool prevents a step misalignment of the conductor strips (angle clamping). It is recommended to order the tool for all connecting systems. It serves in general as „third hand“ while adding the profile joints and allows for a faster and easier assembly.

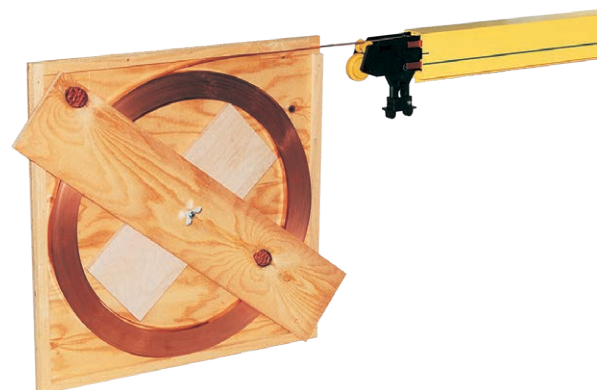

System CS (continuous strip)

Continuous strip type (system CS)

Characteristics

- For conductor guide free of disconnecting points
- Fast and simple on-site assembly
- 35 A, 60 A up to 100 A (100% ED)

For further installation details see installation instructions for program 0842

Description

Technical Data Enclosed Conductor Rails Program 0842 BoxLine

Type	084210- ...				084211- ...		084213- ...		084212- ...	
Rail System Configuration	Continuous Strip (CS)				Plug-in Type (PL)		Bolted Type Angle Clamping (AN)		Bolted Type Joint Clamping (JT)	
Nom. Current at 100% ED and 35°C [A]	10	35	60	100	35	60	35	60	100	140 ¹⁾
Cross Section Area of Conductor [mm ²]	10	10	16	25	10	16	10	16	25	40
Resistance [Ω/m]	0.0808	0.0019	0.0011	0.0006	0.0019	0.0011	0.0019	0.0011	0.0007	0.0004
Impedance at 60Hz [Ω/m]	0.0889	0.0021	0.0012	0.0008	0.0021	0.0012	0.0021	0.0012	0.0008	0.0004
Material	Datametal				Copper					

1) 160A at 80% duty cycle

Basic Variants / Lengths of Profile	4, 5 and 7 poles / 4 m (sub-lengths: 1 m, 2 m, 3 m)
Nominal Voltage	35 ... 690 V (4 and 5 poles); 35 ... 400 V (7 poles)
Installation Position	slot downwards; as shown below
Support Spacing	max. 2000 mm (500 mm curves)
External Dimensions	56 x 90 mm
Travel Speed	up to 150 m/min straight track (< 85 m/min on transfers)

Standard Current Strip Arrangement

4 poles:
L1, L2, L3, PE
5 poles:
L1, L2, L3, 4, PE
7 poles²⁾:
L1, L2, L3, ④, ⑤, ⑥, PE

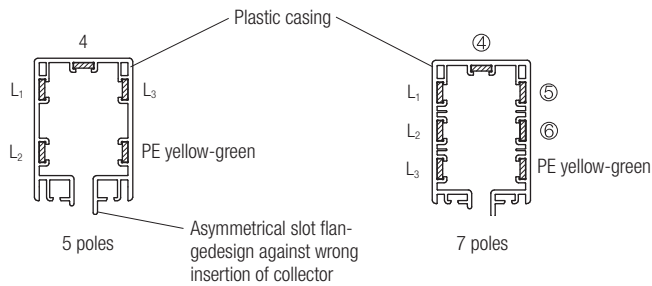

Special Current Strip Arrangement

example 6 poles:
L1, L2, L3, ④, ⑤, PE

	Nominal Current [A]	35	60	100	140
Conductor Cross Section Area	L1, L2, L3, 4 [mm ²]	10	16	25	40
	④, ⑤, ⑥ [mm ²]	10			
	PE [mm ²]	10	16	25	

Permissible Ambient Temperature	-5 to +50°C (Lower temperatures on request)												
Difference in Temperature	Δθ ≤ 40K (Please contact us for higher temperature variations)												
Standard	EN 60204												
Overtoltage Categoric	III (EN 60664-1-2007/VDE0110-1)												
Combustibility of Insulation Cover	regarding UL94 V - 0												
Protection Type	IP 23 (with sealing lips IP 24)												
Intended Use	Supply of crane systems for indoor and protected outdoor areas ³⁾												
Wind speed / Anti-fall guard	max. 60 km/h; for higher wind speed or installation position >3 m, additional anti-fall guard is recommended (see page 21)												
Chemical Resistance of the Profile at an Ambient Temperature of +45°C	<table border="0"> <tr> <td>benzine</td> <td>resistant</td> <td>sodium hydroxide 25%</td> <td>resistant</td> </tr> <tr> <td>mineral oil</td> <td>resistant</td> <td>hydrochlorid acid</td> <td>resistant</td> </tr> <tr> <td>grease</td> <td>resistant</td> <td>sulphuric acid up to 50%</td> <td>resistant</td> </tr> </table> <p>The materials of the conductor rail system are weather resistant and have a high resistance against certain chemicals. For special applications please contact us. Please be careful with solvents and contact sprays.</p>	benzine	resistant	sodium hydroxide 25%	resistant	mineral oil	resistant	hydrochlorid acid	resistant	grease	resistant	sulphuric acid up to 50%	resistant
benzine	resistant	sodium hydroxide 25%	resistant										
mineral oil	resistant	hydrochlorid acid	resistant										
grease	resistant	sulphuric acid up to 50%	resistant										

2) In case of system extension please check the pole disposition. Systems built before 2000 have a different pole disposition (see also MV0842-0020DEF or the respective documentation of the system).

Description

Enclosed Conductor Rail System PL (Plug-in Type, 4 Poles)

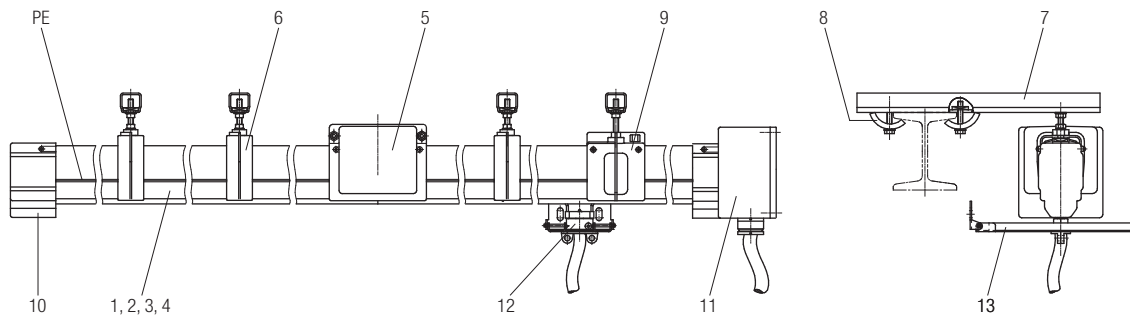

For straight systems (L1, L2, L3, PE) of limited length at low/medium load it is recommended to use 4 pole-"plug-in type" with standard components.

Order Example for a Simple Complete System

Item	Pc.	Parts for 35 A Part No.	Designation	Parts for 60 A Part No.
1	.. ¹⁾	084211-34x4x12	Conductor rail, 4 m long	084211-54x4x12
2	.. ¹⁾	084211-33x4x12	Conductor rail, 3 m long	084211-53x4x12
3	.. ¹⁾	084211-32x4x12	Conductor rail, 2 m long	084211-52x4x12
4	.. ¹⁾	084211-31x4x12	Conductor rail, 1 m long	084211-51x4x12
5	.. ¹⁾	084222-0	Joint cover	084222-0
6	.. ¹⁾	084243-11	Hanger clamp with steel square nut	084243-11
7	.. ¹⁾	020185-0500	Support arm, 500 mm long	020185-0500
8	.. ¹⁾	020181-08	Girder clip with support distance 6-25 mm	020181-08
9	1	084233-11	Anchor clamp with steel square nut	084233-11
10	1	084271	End cap	084271
11	1	084251-051	End feed	084251-052
12	1	084201-4x11 ²⁾	Collector with 1 m connection cable	084201-4x21 ³⁾
13	1	084291-2	Fork-type towing arm	084291-2
14	1	84295-3 (4-5 pole)	Positioning tool for all amp types	84295-3 (4-5 pole)
15	1	84295-4	Edging tools for system CS / IN	84295-4

1) Variable in accordance with the system length

2) Nominal current at 60% duty cycle: 25 A

3) Nominal current at 60% duty cycle: 40 A

Conductor Rails and Joint Covers

System CS (Continuous Strip)

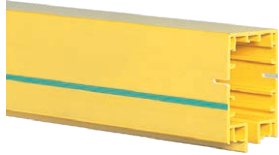

Plastic casing

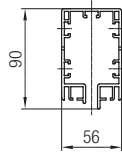

Technical details

- Current strips are delivered in cartons ready for de-coiling
- It is recommended to use datametal for energy and data transmission in corrosive environments and/or at system voltage approx. ≤ 35 V
- Standard current strip arrangement see page 4



Joint cover

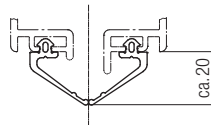
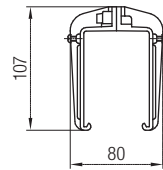

Optional sealing lip see page 21

	Poles	Nom. Current [A]	Strip Material	Max. Length [m]	Weight	Part No.
Plastic Casing	5	-	-	4	5.20 kg	084210-04x5x13
	7 ²⁾	-	-	4	5.40 kg	084210-04x7x12
Current Strip	-	35	Copper	300	0.08 kg/m	084214-3xL¹⁾
	-	60		200	0.15 kg/m	084214-5xL¹⁾
	-	100		100	0.23 kg/m	084214-6xL¹⁾
	-	10	Datametal	300	0.07 kg/m	084214-8xL¹⁾
Joint Cover	-	-	-	-	0.12 kg	084221-0

1) L = requested strip length per pole [m] 2) not approved for 35 A current strips

Recommendation: a connector of the AN system should be ordered per system if a division of the tape is necessary during assembly

System PL (Plug-in Type)

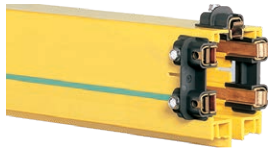

Conductor rail

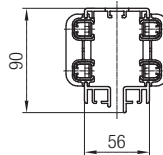

Technical details

Standard current strip arrangement see page 4



Joint cover

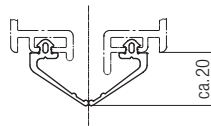
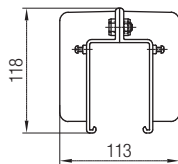

Optional sealing lip see page 21

	Poles	Nom. Current [A]	Strip Material	Max. Length [m]	Weight	Part No.
Conductor Rail	4	35	Copper	4	7.22	084211-34x4x12
	5				7.63	084211-34x5x13
	4	60	Copper		8.21	084211-54x4x12
	5				8.87	084211-54x5x13
Joint Cover	-	-	-	-	0.24	084222-0

Conductor Rails and Joint Covers

System JT (Joint Clamping)

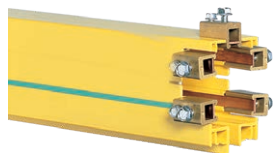

Plastic casing

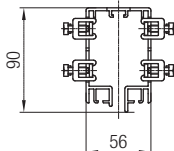

Technical details

Standard current strip arrangement see page 4



Joint cover

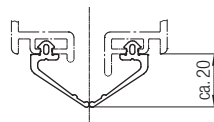
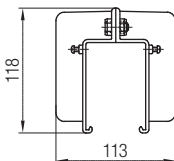

Optional sealing lip see page 21

	Poles	Nom. Current [A]	Strip Material	Max. Length [m]	Weight [kg]	Part No.
Conductor rail	4	100	Copper	4	9.40	084212-64x4x12
	5				10.40	084212-64x5x13
	4	140	Copper		11.15	084212-74x4x12
	5				12.64	084212-74x5x13
Joint cover	-	-	-	-	0.24	084222-0

System AN (Angle Clamping)

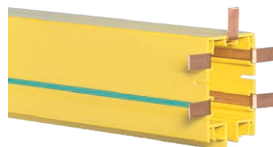

Conductor rail

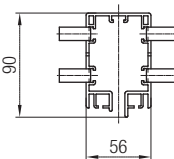

Technical details

• Standard current strip arrangement see page 4

Important note

• The positioning tool (positioning block) 084295-3 or 08-V015-0466 (page 22) is mandatory for the connection of the guide wire!
The positioning block serves as a counter point for the assembly of the connecting position and avoids any offset of the contact strip.



Joint cover

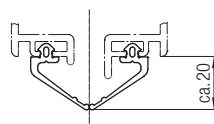
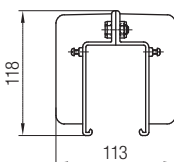

Optional sealing lip see page 21

	Poles	Nom. Current [A]	Strip Material	Max. Length [m]	Weight [kg]	Part No.
Conductor Rail	4	35	Copper	4	6.98	084213-34x4x12
	5				7.34	084213-34x5x13
	4	60	Copper		8.03	084213-54x4x12
	5				8.60	084213-54x5x13
	7				9.36	084213-54x7x15
Joint Cover	4	-	-	-	0.32	084224-4 ¹⁾
	5				0.34	084224-5 ¹⁾
	7				0.38	084224-7 ¹⁾

1) incl. covering terminals L2 and ©

Rail Curves

General Rail Curve Data

- There is a distinction between horizontal-/vertical curves and inner-/outer curves.
- The minimum radius depends on the collector type.
- The hanger clamp distance at curves shall not exceed 500 mm.
- The overall curve length should not exceed 2360 mm.
- AN (angle clamping) is the preferred joint system for curves. Appropriate conductor rail connection adapters are available for joining with other systems (e.g. system PL „plug-in type“).
- Curves act as anchor points within the system. Therefore, if expansion is not accommodated by the steel structure (i.e. slotted holes at the attachment point), the use of Expansion elements is recommended (see pages 14/15).
- Adaption segments (200 mm long) for system PL available

Horizontal Curves

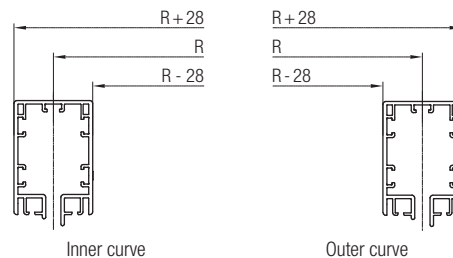
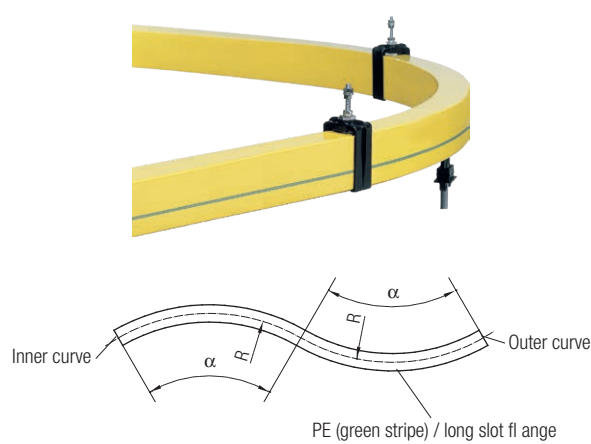

Radius R [mm]	Angle α
$800 \leq R < 2750$ ¹⁾	On request
$2750 \leq R < 3000$	0° - 45°
$3000 \leq R < 4500$	0° - 30°
$4500 \leq R < 6000$	0° - 22.5°
$6000 \leq R$	On request

For radii greater than/equal to 27000 mm, bending is not required.

1) Special collector required for this configuration

Vertical Curves

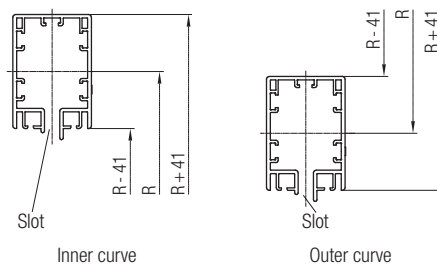
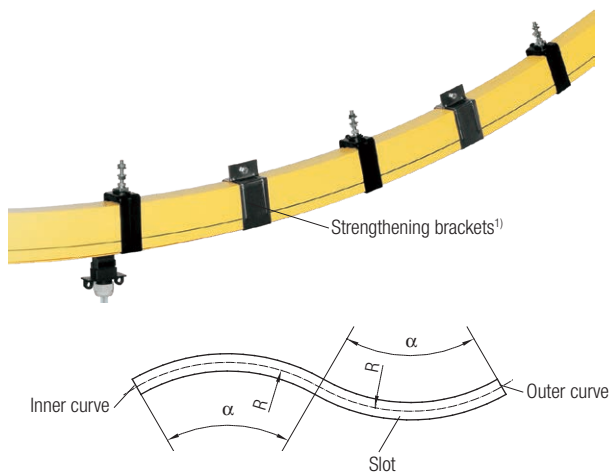

Radius R [mm]	Angle α
$3000 \leq R < 5000$ ²⁾	On request
$5000 \leq R < 6000$	0° - 22.5°
$6000 \leq R$	On request

1) See page 21

2) Special collector required for this configuration

Order Number Code for Curve, System AN (Angle Clamping)

H = Horizontal / V = Vertical	084213	X	B	X	2750	-	030	X	x	X	x	12	Poles: 4, 5
I = Inner- / A = Outer curve													Current: 3 = 35A; 5 = 60A
Radius (e.g. 2750 mm)													Angle α (e.g. 30°)

Adapters for other systems on request!

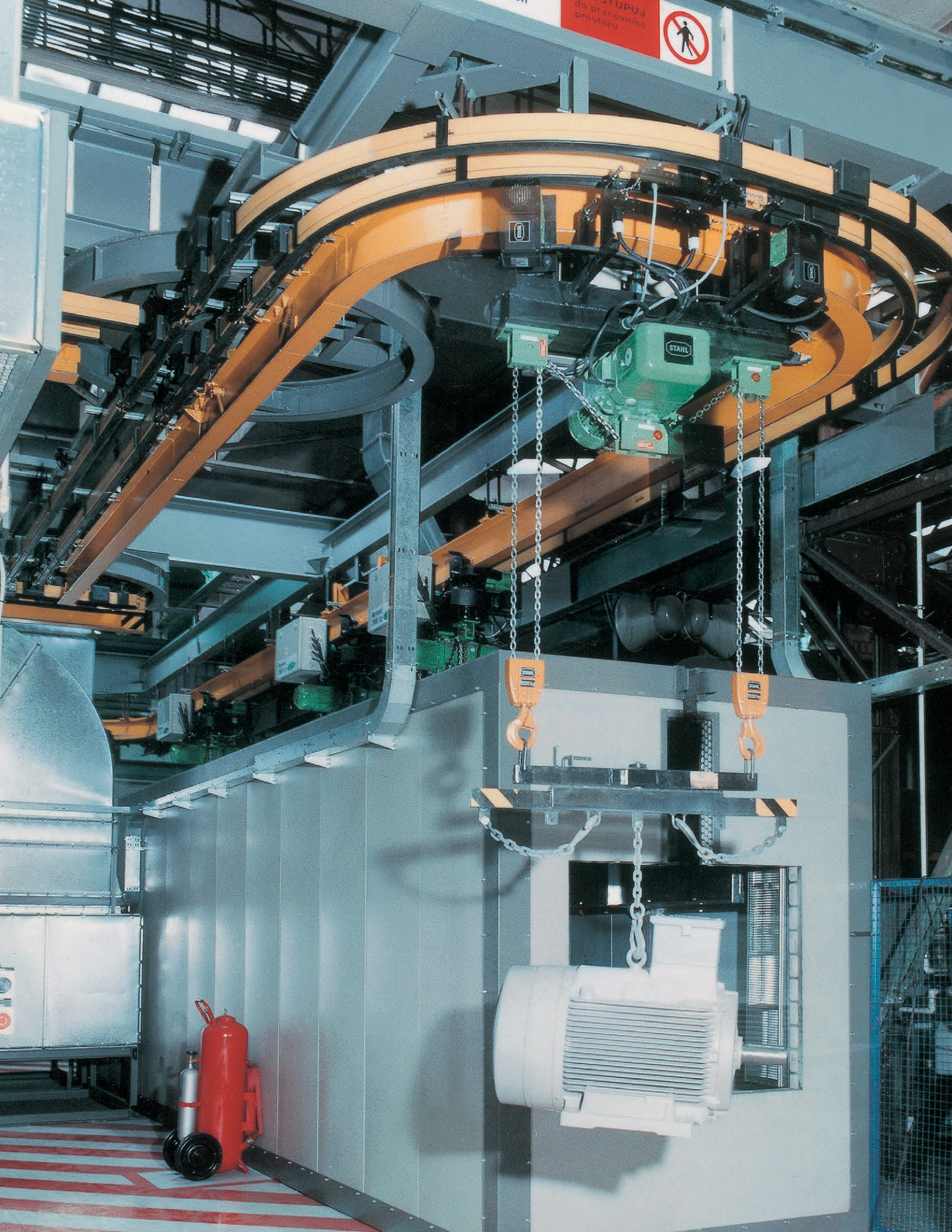

Hanger Clamps and Anchor Clamps

Hanger Clamp



Type with normal steel hex nut

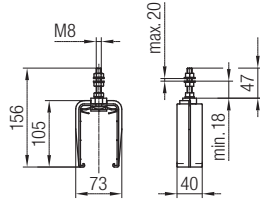

Part No. 084241-11

Technical details

- Material: plastic; steel
- Snap-in type; swivelling
- Support distance ≤ 2000 mm
- Weight: 0.11 kg



Type with steel square nut

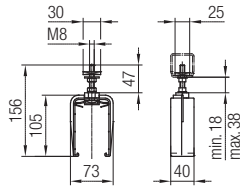

Part No. 084243-11

Technical details

- Material: plastic; steel
- Snap-in type; swivelling
- For support arm assembly
- Support distance ≤ 2000 mm
- Weight: 0.14 kg

Anchor Clamp



Type with normal steel hex nut

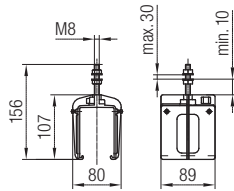

Part No. 084231-11

Technical details

- Material: plastic; steel
- Weight: 0.16 kg



Type with steel square nut

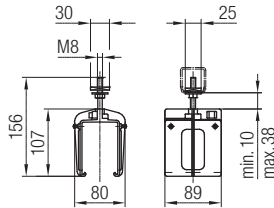

Part No. 084233-11

Technical details

- Material: plastic; steel
- For support arm assembly
- Weight: 0.18 kg

Hanger Clamp for Higher Temperature Range

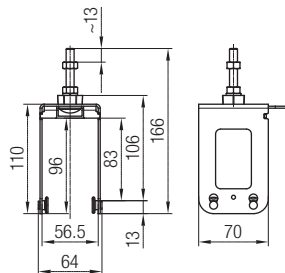

Part No. 084245-22

Technical details

- Material: galvanised steel
- Weight: 0.4 kg
- Incl. universal hex and square nuts set for flexible installation

Notes

- Hanger clamp with integrated rollers
- Recommended for application with higher temperature range (temperature range $> 40K$)

End Feeds and End Caps

End Feed up to 60A for CS (Continuous Strip), PL (Plug-in Type) and AN (Angle Clamping)

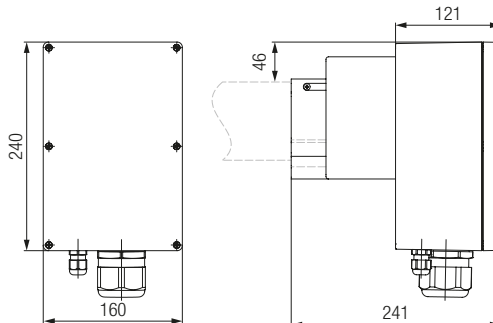

Technical details

- Housing material: plastic
- Cable lugs included
- For joint systems PL and AN few modifications are required on-site.
- Further details see installation instructions program 0842

Part No.	Poles up to	Gland	Nom. Current [A]	Cable Lug [mm ²]	Weight [kg]
084251-051	5	M25	35	10	0.71
084251-052		M32	60	16	0.71
084251-076	7	M32 + M20	60	16	0.85

End Feed up to 100A for CS (Continuous Strip) and up to 140A for JT (Joint Clamping)

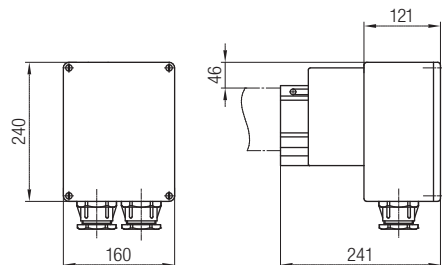

Technical details

- Housing material: plastic
- Cable lugs included

Part No.	Poles up to	Gland	Nom. Current [A]	Cable Lug [mm ²]	Weight [kg]
084251-053x60	5	M50	100	25	1.30
084251-053x70		M50	140	35	1.30
084251-077x60	7	1 x M50; 1 x M20	100	25 ¹⁾	1.35
084251-077x70		1 x M50; 1 x M20	140	35 ²⁾	1.35

1) 4 cable lugs 25 mm² (max. 96A) + 3 cable lugs 2.5 mm² (max. 26A)

2) 4 cable lugs 35 mm² (max. 119A) + 3 cable lugs 2.5 mm² (max. 26A)

End Cap



Standard type

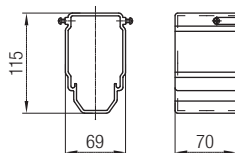

Part No. 084271

Technical details

- Material: plastic
- Weight: 0.13 kg



Type for connection of bus terminating resistors

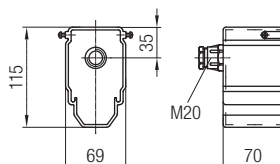

Part No. 084272

Technical details

- Material: plastic
- Weight: 0.14 kg

In-line Feeds

In-line Feeds with Single Core Cable Entry up to 60 A

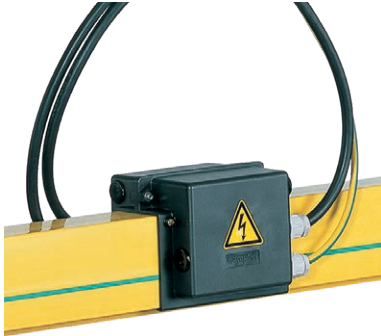

Technical details

- Single core
- 2 separate feedings for 7 pole systems

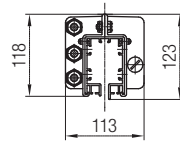

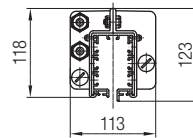
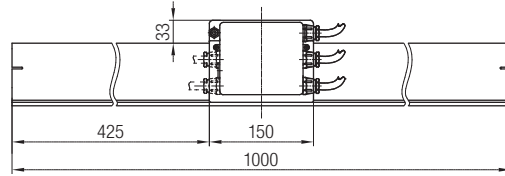

4/5 poles

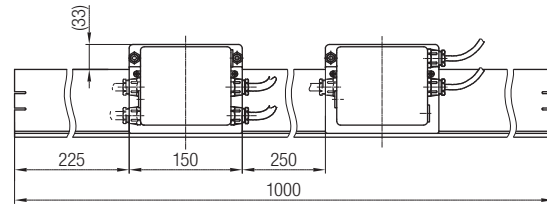

7 poles



In-line Feeds for System	Poles	Nom. Current [A]	Feeding			Control Feeding			Weight [kg]	Part No.
			[Pc.]	L [m]	[mm ²]	[Pc.]	L [m]	[mm ²]		
 CS (continuous strip)	4	up to 60	4	2	10	-	-	-	3.80	084252-040x52
	5		5	2	10	-	-	-	4.30	084252-050x53
	7		4	2	10	3	2	2.5	4.40	084252-070x55
 PL (plug-in type)	4	35	4	2	10	-	-	-	4.20	084252-240x32
	5		5	2	10	-	-	-	4.90	084252-250x33
	4	60	4	2	10	-	-	-	4.40	084252-240x52
	5		5	2	10	-	-	-	5.20	084252-250x53
	7	60	4	2	10	3	2	2.5	5.40	084252-170x55

L = connection cable length

AN (angle clamping)

In-line Feeds Joint Covers AN (Angle Clamping)

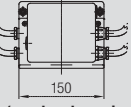
In-line Feeds for System AN	Poles	Nom. Current [A]	Feeding			Control Feeding			Weight [kg]	Part No.
			[Pc.]	L [m]	[mm ²]	[Pc.]	L [m]	[mm ²]		
 AN (angle clamping)	4	up to 60	4	2	10	-	-	-	1.90	084252-140x50
	5		5	2	10	-	-	-	2.50	084252-150x50
For installation instead of joint cover.										

L = connection cable length



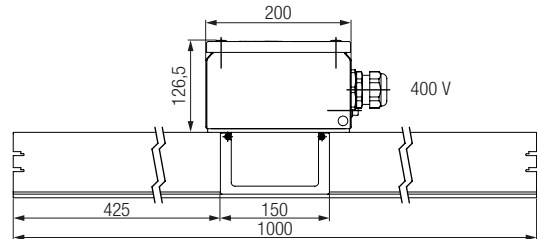
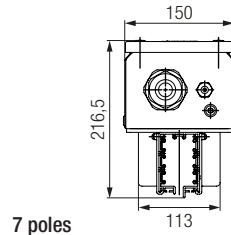
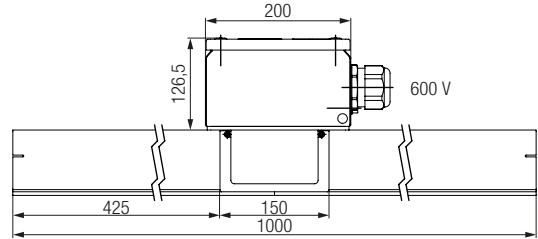
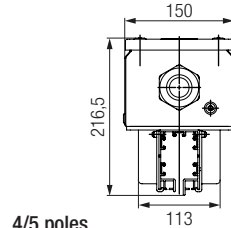
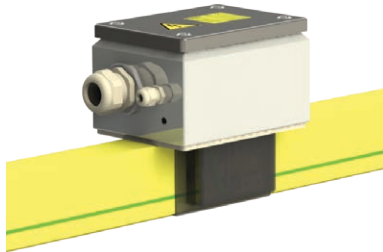

In-line Feeds

In-line Feeds with Terminal Box up to 140 A



Technical details

- Terminal box
- 2 separate cable fittings for 7 pole systems

In-line Feeds for System	Poles	Nom. Current [A]	Cable Gland	Feeding		Control Feeding			Weight [kg]	Part No.
				Cable Lugs [Pc.]	Cable Lugs [mm ²]	Cable Gland	Cable Lugs [Pc.]	Cable Lugs [mm ²]		
 CS (continuous strip)	4	up to 60	M32	4	16	-	-	-	2.50	084252-042x52
	5			-		-	-	2.60	084252-052x53	
	7			11		3	2.5	3.20	084252-076x55	
	4	100	M40	4	25	-	-	-	2.40	084252-043x62
	5			-		-	-	2.50	084252-053x63	
	7			11		3	2.5	3.10	084252-077x65	
 PL (plug-in type)	4	35	M25	4	10	-	-	-	2.90	084252-241x32
	5			-		-	-	3.10	084252-251x33	
	4	60	M32	4	16	-	-	-	3.30	084252-242x52
	5			-		-	-	3.60	084252-252x53	
 AN (angle clamping)	4	35	M25	4	10	-	-	-	2.93	084252-141x32
	5			-		-	-	3.03	084252-151x33	
	4	60	M32	4	16	-	-	-	3.20	084252-142x52
	5			-		-	-	3.40	084252-152x53	
	7			11		3	2.5	4.00	084252-176x55	
 JT (joint clamping)	4	100	M40	4	25 ¹⁾	-	-	-	3.65	084252-343x62
	5			-		-	-	4.04	084252-353x63	
	4	140		4	35 ²⁾	-	-	-	4.03	084252-343x72
	5			-		-	-	4.50	084252-353x73	

1) Max. 96A with cable lug 25 mm²

2) Max. 119A with cable lug 35 mm²

Expansion Elements

General Expansion Element Data

Variations in ambient temperature coupled with the normal electrical heating of the conductors causes linear expansion. Expansion Elements are used to accommodate the movement in the system caused by thermal expansion. The quantity of expansion elements required is determined by the climate and the system or segment length. Additional feeding is not required when using expansion elements as the electrical continuity of the system is not interrupted.

	Expansion elements
	Anchor point
	End feed

Max. Length System PL, JT, CS, AN

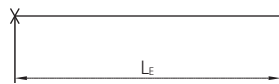

Straight track with end feed¹⁾

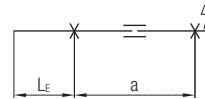

Between two fixed points, e.g. anchor clamps or curves

Difference in Temperature [°K]	Max. System Length without Expansion Elements	Section Length with one Expansion Element	
	L_E [m]	a [m]	
	System PL, JT, CS ²⁾ and AN	System CS ²⁾	System PL, JT and AN
15	225	120	120
20	170	73	101
25	135	61	85
30	110	49	69
40	85	37	49
50	70	29	41
60	60	25	33
70	-	21	29
80	-	17	25

1) On straight track and center feed the max. system length will be doubled.

2) Max. strip insertion length on system CS; 100A-strip = 100m; 60A-strip = 200m; 35A-strip = 300m

Please note: $L_{max} = 2 \times L_E$

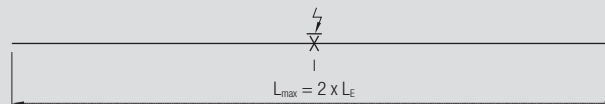

Longer systems can be achieved by connecting sections with expansion elements.

The difference in current consumption/load at various sections of the system can effect the ideal quantity and location of expansion elements.

Example: Setting the Expansion Element Depending on the Temperature

ΔT

- Lowest ambient temperature during system operation t_{min} : 5°C
- Ambient temp during installation t_{in} : 15°C
- Highest ambient temperature during system operation t_{max} : 45°C

 $30^\circ\text{C} = \Delta T_1$

Air gap read from diagram: $s = 75 \text{ mm}$

Air gap calculated: $s = 100 \frac{\Delta T_1}{\Delta T} = 75 \text{ mm}$

Installation distance K: $K = 100 + s = 175 \text{ mm}$

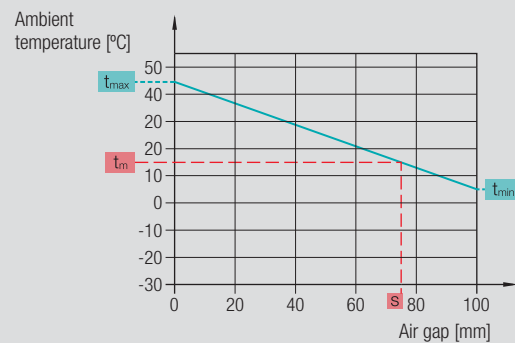

Expansion Elements

Expansion Elements (with 100 mm Expansion) for System CS (Continuous Strip)

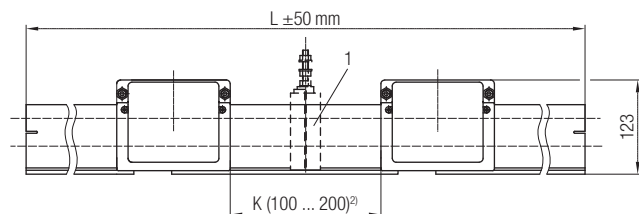
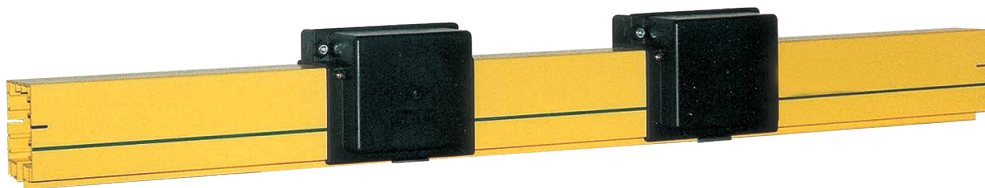

- 1) Hanger clamp to be ordered separately
2) Reference dimension K (see page 14)

Notes

- Expansion points of the support structure may influence amount and mounting position of rail expansion elements
- Conductor strips are mounted continuous

Part No.	Poles	Length L [mm]	Weight [kg]
084260-5x62	4.5	1000	1.90
084260-7x65	7.0		1.97

Expansion Elements (with 100 mm Expansion) for the Systems PL, JT and AN

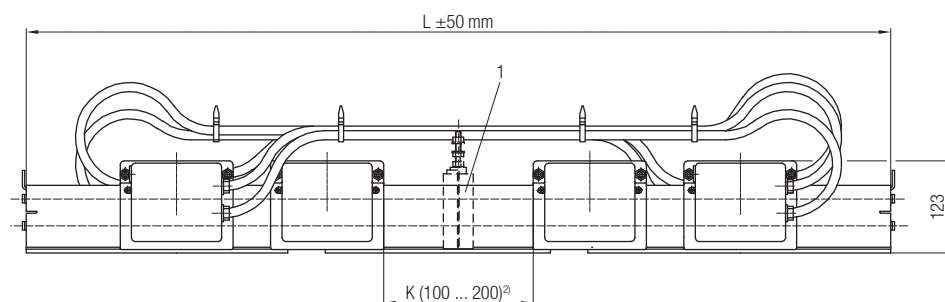
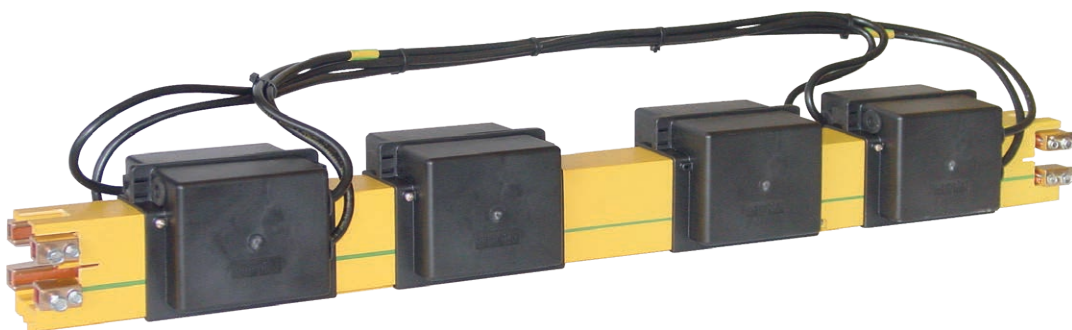

- 1) Hanger clamp to be ordered separately
2) Reference dimension K (see page 14)

System	Poles	Length L [mm]	Current [A]	Weight [kg]	Order No.	Current [A]	Weight [kg]	Order No.
PL (Plug-in Type)	4	1000	35	4.81	084261-4x32	60	4.85	084261-4x52
	5	1000		5.33	084261-5x33		5.44	084261-5x53
JT (Joint Clamping)	4	1000	100	5.11	084262-4x62	140 ³⁾	5.26	084262-4x72
	5	1000		5.73	084262-5x63		5.94	084262-5x73
AN (Angle Clamping)	4	1000	35	4.57	084263-4x32	60	4.67	084263-4x52
	5	1000		5.04	084263-5x33		5.17	084263-5x53

3) Max. 116 A with ED 100%

Pick-up Guides

Pick-up Guides for Transfer Points

Pick-up guides for transfer points are used for applications such as transfer switches where the collector does not entirely exit from the rail system. The pick-up serves for the introduction of the collector trolley and can compensate lateral movements of ± 8 mm and vertical deflections of ± 3 mm. We recommend adjustments below 3 mm, target 0 mm.

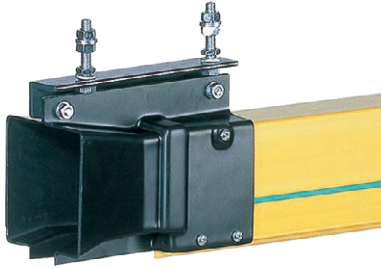

Technical details



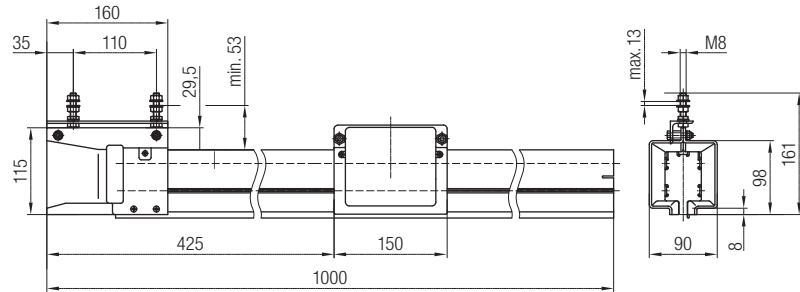

- Permissible rail misalignment:
Vertical ± 3 mm
Lateral ± 3 mm
- Pick-up guide spacing: ≤ 10 mm
- For the installation of pick-up guides apply the spring-loaded towing arm 084291-4 for the collector
- Pick-up guides can be equipped with power feeds; see description for pickup guides for transfer points
- Safety conditions (see collector)

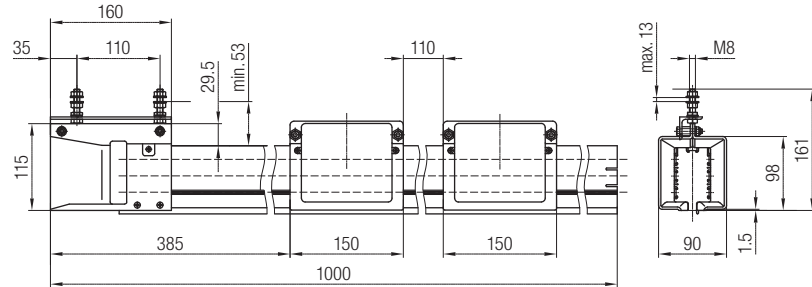

4/5 poles - type "left" for CS (continuous strip)



7 poles - type "left" for CS (continuous strip)

Pick-up Guides at Rail End	Nom. Current [A]	Type	Max. Weight [kg]	Part No.		
				4 Poles	5 Poles	7 Poles
 CS (continuous strip)	up to 100	Right	3.94	084282-5x63x01		084282-7x65x01
		Left		084282-5x63x02		084282-7x65x02
 PL (plug-in type)	35	Right	4.45	084282-4x32x11	084282-5x33x11	
		Left		084282-4x32x12	084282-5x33x12	
	60	Right	4.60	084282-4x52x11	084282-5x53x11	
		Left		084282-4x52x12	084282-5x53x12	
 AN (angle clamping)	35	Right	4.20	084282-4x32x21	084282-5x33x21	084282-7x35x21
		Left		084282-4x32x22	084282-5x33x22	084282-7x35x22
	60	Right	4.36	084282-4x52x21	084282-5x53x21	084282-7x55x21
		Left		084282-4x52x22	084282-5x53x22	084282-7x55x22
 JT (joint clamping)	100	Right	4.79	084282-4x62x31	084282-5x63x31	
		Left		084282-4x62x32	084282-5x63x32	
	140	Right	4.89	084282-4x72x31	084282-5x73x31	
		Left		084282-4x72x32	084282-5x73x32	

Conversion Retrofit Kits to Add a Power Feed Point to Pick-up Guides/Transfer Points

Part No.	Poles up to	Nom. Current [A]	Weight [kg]
084283-5	5	60	0.38
084283-7	7		0.75

Scope of delivery

Exchange cover with cable glands including connecting parts and fasteners (without cable).

Pick-up Guides

Pick-up Guides for Entrance Points

Pick-up guides for entrance points are used to guide the collector back into the system in applications where the collector has completed exited the conductor rail system. The pick-up serves for the introduction of the collector trolley and can compensate lateral offsets of ± 15 mm and a vertical deflection of ± 10 mm. We recommend adjustment below 3 mm, target 0 mm.

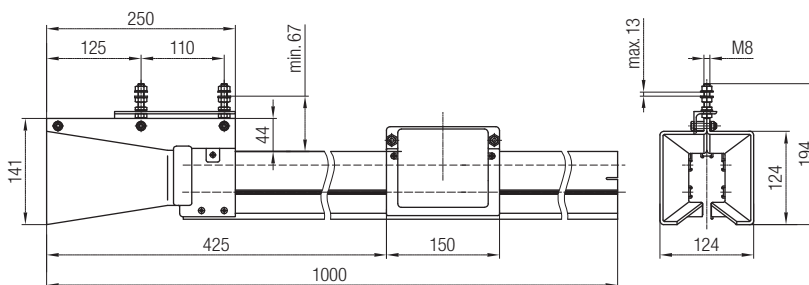
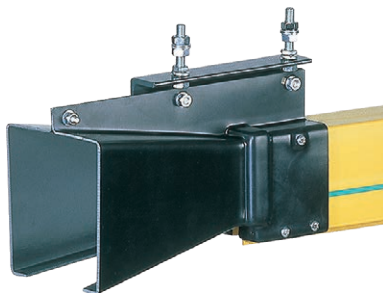



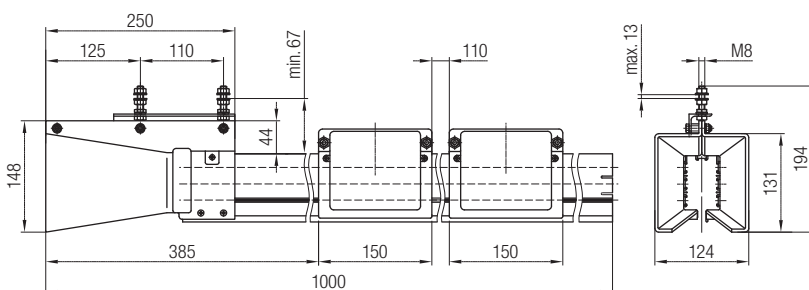

4/5 poles - type "left" for CS (continuous strip)

Technical details

- Permissible rail misalignment:
Vertical ± 3 mm
Lateral ± 3 mm
- Use spring-loaded towing arm 084291-4 for the collectors
- Pick-up guides can be equipped with feeds; see description for pick-up guides for transfer points
- Safety conditions (see collector)



7 poles - type "left" for CS (continuous strip)

Pick-up Guides at Rail End	Nom. Current [A]	Type	Max. Weight [kg]	Part No.		7 Poles ¹⁾
				4 Poles	5 Poles	
 CS (continuous strip)	100	Right	3.60	084281-5x63x01	084281-5x63x01	084281-7x65x01
		Left		084281-5x63x02	084281-5x63x02	084281-7x65x02
 PL (plug-in type)	35	Right	4.00	084281-4x32x11	084281-5x33x11	
		Left		084281-4x32x12	084281-5x33x12	
	60	Right	4.10	084281-4x52x11	084281-5x53x11	
		Left		084281-4x52x12	084281-5x53x12	
 AN (angle clamping)	35	Right	3.85	084281-4x32x21	084281-5x33x21	084281-7x35x21
		Left		084281-4x32x22	084281-5x33x22	084281-7x35x22
	60	Right	4.02	084281-4x52x21	084281-5x53x21	084281-7x55x21
		Left		084281-4x52x22	084281-5x53x22	084281-7x55x22
 JT (joint clamping)	100	Right	4.30	084281-4x62x31	084281-5x63x31	
		Left		084281-4x62x32	084281-5x63x32	
	140	Right	4.40	084281-4x72x31	084281-5x73x31	
		Left		084281-4x72x32	084281-5x73x32	

1) 7 poles on request. The different types depend on the different system parameters. Use our technical support to plan the design

Pick-up Working Range

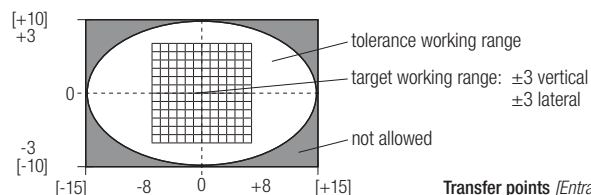

Function notes:

- Current collectors have to be switched free from tension outside the Conductor Rail System.
- Protection against contacts has to be provided by the customer.

Transfer points [Entrance points]; all measurements in mm

Collectors and Accessories

Collector with Connection Cable



Collector 5 poles

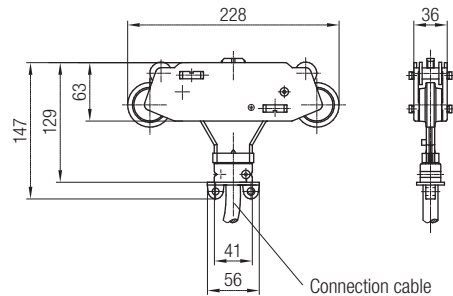

Collector 4,6 and 7 poles

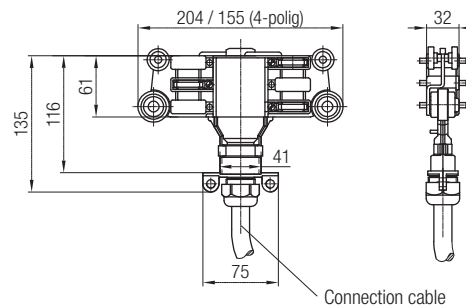

Poles	Nom. Current [A]	Cable Cross Section [mm ²]	Length = 1 m		Connection Cable Length = 3 m		Length = 5 m	
			Part No.	Weight [kg]	Part No.	Weight [kg]	Part No.	Weight [kg]
4	25	2.5	084203-4x11x01	0.58	084203-4x13x01	1.00	084203-4x15x01	1.30
	34	4.0	084203-4x21x01	0.71	084203-4x23x01	1.27	084203-4x25x01	1.57
5	25	2.5	084201-5x11	0.63	084201-5x13	1.17	084201-5x15	1.47
	34	4.0	084201-5x21	0.80	084201-5x23	1.52	084201-5x25	1.92
7	25	2.5	084203-7x11x01	0.82	084203-7x13x01	1.28	084203-7x15x01	1.58
	34	4.0	084203-7x21x01	1.07	084203-7x23x01	1.37	084203-7x25x01	1.65

Technical details

- Cable length: 1, 3 and 5 m for connection to the terminal box provided by the customer
- Collector shoe material: copper graphite
- Alternative cable for low temperature on request
- Conductor rail radius: horizontal arrangement: $R_{min} = 2750$ mm
vertical arrangement: $R_{min} = 5000$ mm

Double Collector (for higher current load or converter drives)

For the joining of identical double collectors to create a dual collector arrangement, we can provide the **towing arm crossbar Part No. 084291-3**

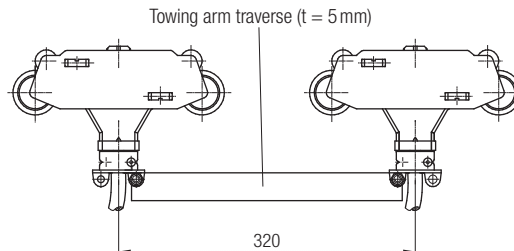

Note

A sufficient quantity of collectors must be used in arrangements that contain pick-up guides or isolations sections to ensure that collectors are not overloaded as other collectors exit the system (i.e. at pick-up guides).

Collectors and Accessories

Collector up to 7 Poles; with Single Cores in a Flexible Conduit

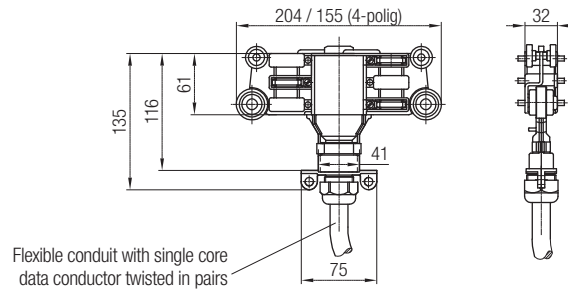

Poles	Nom. Current [A]	Cable Cross Section [mm ²]	Length = 1 m		Corrugated Hose Length = 3 m		Length = 5 m	
			Part No.	Weight [kg]	Part No.	Weight [kg]	Part No.	Weight [kg]
6	25	2.5	084203-6x31x02	0.80	084203-6x33x02	1.30	084203-6x35x02	1.59
	34	4.0	084203-6x41x02	0.82	084203-6x43x02	1.35	084203-6x45x02	1.64
7	25	2.5	084203-7x31x02	0.85	084203-7x33x02	1.30	084203-7x35x02	1.59
	34	4.0	084203-7x41x02	1.09	084203-7x43x02	1.39	084203-7x45x02	1.69

Technical details

- Collector for data transmission e.g. in connection with Conductix-Wampfler powertrans system
- Carbon material for energy: 4 x copper graphite
- Collector shoe material: copper graphite, 2 (3) x silver graphite (6 poles: ☒, ☒; 7 poles: ☒, ☒, ☒)

Note

To increase the contact reliability or for applications with transfers, double collectors should be used with the crossbar (Part No. 084291-3). Please note the general advice for double collectors (preceding page).

Towing Arm

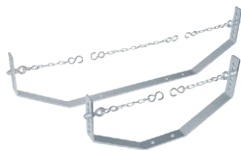

Chain towing arm

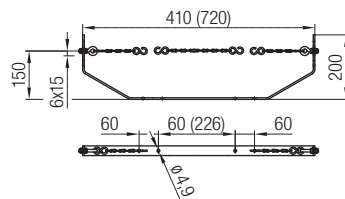

Part No.	Type	a [mm]	Material	Weight [kg]
084291-11	Simple	410	Steel, galvanized	0.89
084291-12	Double	720		1.28

Notes

- Horizontal and vertical installation possible
- Not suited for use with transfers
- Hints for application see page 2



Fork-type towing arm

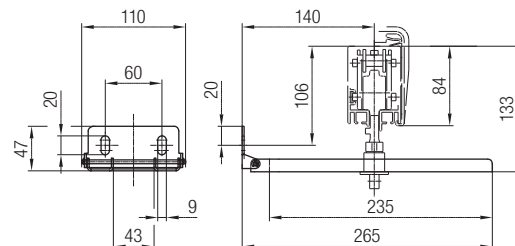

Part No. 084291-2

Technical details

- Material: steel, galvanized
- Weight: 0.37 kg

Notes

- Only for double collector
- Hints for application see page 2

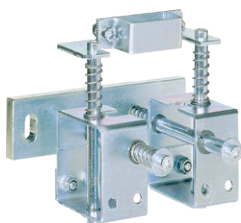

Spring-loaded towing arm

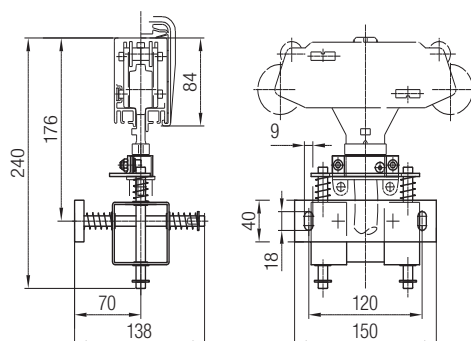

Part No. 084291-4

Technical details

- Material: steel, galvanized
- Weight: 1.16 kg
- Max horizontal misalignment: ± 15 mm
- Max vertical misalignment: ± 10 mm
- For use with pick-up guides
- Strengthening brackets recommended at a distance of 250 mm
- Further spring-loaded towing arms on request



Wear Parts and Accessories

Sealing Lip

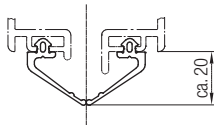

Part No.	Description	Scope of Delivery	Weight [kg]
084293-1-025	Sealing Lip 2 x 25 m	1 x 50 m	5,7
084293-1-050	2 x 50 m	1 x 100 m	11,4
084293-1-100	2 x 100 m	2 x 100 m	22,8

Notes

- Material: EPDM
- Optimum accessories for a better protection against impurities and humidity, e.g. driving rain
- The lip insertion tool (Part No. 084293-4) is required for assembly

Reinforcing Bracket for Plastic Housing and Storm and Anti-fall guard Safety Device



Part No.	Material	Weight [kg]
084295-1	Steel, galvanized	0.08
08-S280-0564 ¹⁾		0.09

Note

The reinforcing brackets serve to improve the profile rigidity, e.g. in the area of the vertical curves

¹⁾ With additional safety rope as storm and anti-fall guard safety device. Shall be provided on every second rail.

Conversion Retrofit Kits to Add a Power Feed Point to Pick-up Guides/Transfer Points

Part No.	Poles up to	Nom. Current [A]	Weight [kg]
084283-5	5	60	0.38
084283-7	7		0.75

Scope of delivery

Exchange covers with cable glands including connecting material and fasteners (without cable)

Half Shells

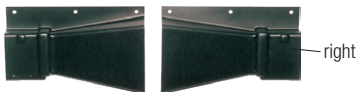

Half shells for pick-up guides

Part No. Half Shell "Left"	Part No. Half Shell "Right"	Poles	Material	Weight [kg]
08-E011-0163	08-E011-0162	4 / 5	Plastic	0.14
08-E011-0180	08-E011-0179	7		0.14



Half shells for transfer points

Part No. Half Shell "Left"	Part No. Half Shell "Right"	Poles	Material	Weight [kg]
08-E011-0165	08-E011-0164	4 / 5	Plastic	0.06
08-E011-0182	08-E011-0181	7		0.06

Notes

- All pick-up units are equipped with replaceable half shells
- Replacement of the complete pick up unit not needed

Collectors Shoes for Collectors



(C)



(A)



(B)

Part No.	Nom. Current 60% ED [A]	Material	Type of Construction	Installation Position	Weight [kg]
081007-212	25	Copper graphite	C	L1, - L3, PE, 4	0.14
081007-111	40		A	L1 - L3, PE, ⑤+⑥	
081007-113	40		B	④	
081007-114	40	Ag-Graphit	A	DATA ⑤+⑥	
08-K154-0261 ¹⁾	10		B	DATA ④	
08-K154-0262 ¹⁾	10				

For order of replacement carbon collector shoes, please observe type of construction, place of installation and amperage.

Cu = copper

Ag = silver

¹⁾ coals containing silver (Ag) only to be used in existing plants.

Assembly Tools

Strip Insertion Trolley for System CS (Continuous Strip)

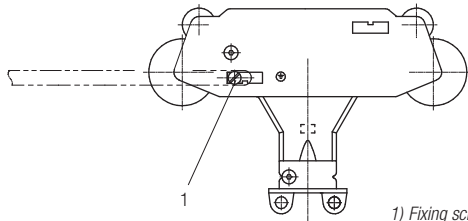

1) Fixing screw for current strip (do not pull tight)

Part No.	Poles up to	Weight [kg]
084292-1x5	5	0.22
084292-1x7	7	0.24

De-coil Unit for Simplified Strip Insertion - Optional (System CS)



Part No.	Strip Type				Weight [kg]
	Datametal	35 A	60 A	100 A	
08-V015-0404	40 ≤ L ≤ 130 m	40 ≤ L ≤ 130 m	40 ≤ L ≤ 65 m	30 ≤ L ≤ 40 m	2.77
08-V015-0403	130 ≤ L ≤ 300 m	130 ≤ L ≤ 300 m	65 ≤ L ≤ 200 m	40 ≤ L ≤ 100 m	6.15
08-W100-0561	Standard rate for current strip				

Note

For easy installation of current strips specially "100A"-strip.

Bending Device for Chamfering the Copper Strip for System AN (Angle Clamping)



Part No. 084295-4

Technical detail
Weight: 0.05 kg

Positioning Block for System AN (Angle Clamping)



Part No.	Poles	Material	Weight [kg]
08-V015-0466	5	Hardwood	0.38
084295-3	7	Plastic	

Note

The positioning block serves as a counter point for the assembly of the connecting position and avoids any offset of the contact strip. It is required for the assembly of the angle clamping. Recommended as a „third hand“ for all connecting systems.

Insertion Tool for Sealing Lip

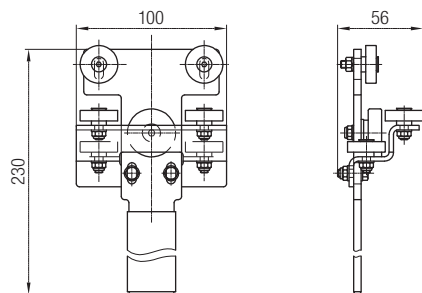

Part No. 084293-4

Technical details

- Article: insertion tool
- Weight: 0.60 kg

Notes

- Mounting tool to insert the optional sealing lip
- The use of a weak soap and water or a mineral oil free lubricant can be used to aid in the insertion of the sealing lips

Assembly Tools

Support Arm (Optional)

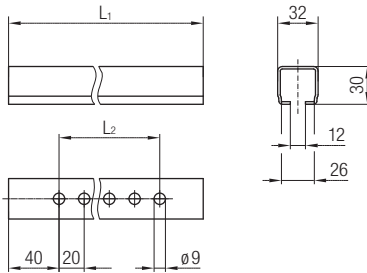

Use with
hanger and anchor clamps with steel square nut

Part No.	L ₁ [mm]	L ₂ [mm]	Material	Weight [kg]
020185-0250	250	200	Steel, galvanized	0.39
020185-0315	315	260		0.50
020185-0400	400	340		0.63
020185-0500	500	340		0.78

Girder Clip (Optional)

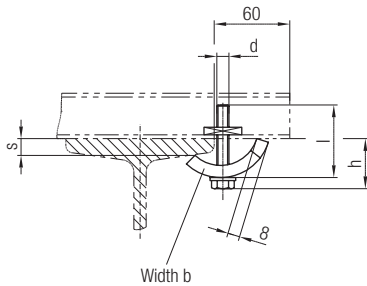

Use with
for rail and anchor clamps with groove stone

Part No.	s ¹⁾ [mm]	d [mm]	l [mm]	h ²⁾ [mm]	b [mm]	Material	Weight [kg]
020181-08	6 - 25	M8	50	31 - 40	30	Plate and fasteners: steel, galvanized Bracket: steel, galvanized	0.15
020180-08x36	18 - 36		65	42 - 60			0.22

1) Support distance
2) Installation height

Weld-on Bracket for Support Arm (Optional)

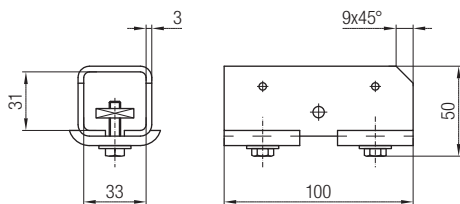





Part No. 020285

Technical details

- Material:
- Bracket: steel, unfinished
- Plate and fasteners: steel, galvanized;
- Weight: 0.42 kg

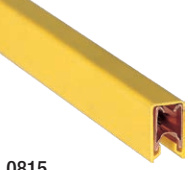
Program Overview

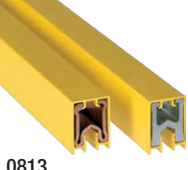
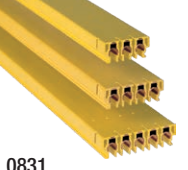
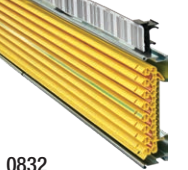
Conductor Rails

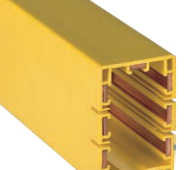
	Program	Nominal Current ¹⁾	Voltage Grade	Support Spacing	Rail Length	Outside-Dimensions
Single Pole Insulated Conductor Rail	 0811	10-100 A	500 V	0.4-1.0 m	4 m	14.7 x 15.5 mm
	 0815	100 A	500 V	0.5 m	4 m	9.6 x 15.2 mm
	 0812	25-400 A	690 V	1,5 m (3,2 m) ¹⁾	4 m	18 x 26 mm
	 0813	200-1250 A	690 V	2.5 m	5 m	32 x 42 mm
Multipole Conductor Rail	 0831	10-125 A (140 A at 80% duty cycle)	500 V	1 m (3,2 m) ¹⁾	4 m	3-pole: 26 x 62 mm 4-pole: 26 x 80 mm 5-pole: 26 x 98 mm
	 0832	25-200 A (200 A at 80% duty cycle)	690 V	3.2 m	4 m	4-pole 200 x 50 mm
	 0835	Complete system: 32 A Rail system: 100 A	AC Voltage: 230/400 V AC Earth/Low voltage: min. 24 up to 48 V DC/AC	0.8 m	4 m	196 x 48 mm (incl. System support 220 x 50 mm)
Enclosed Conductor Rail	 0842	35-140 (160 A at 80% duty cycle)	690 V (4 and 5 poles) 400 v (7 poles)	2 m	4 m	56 x 90 mm

¹⁾ 3.2 m in combination with support structure ProShell

Other Products from Conductix-Wampfler

The products described in this catalog represent a few of the products from the broad spectrum of Conductix-Wampfler components and systems for the transfer of energy, data, gases, and fluids. The solutions we deliver for your applications are based on your specific requirements. In many cases, a combination of several different Conductix-Wampfler products are needed to fill the application. You can count on all of Conductix-Wampfler's business units for hands-on engineering support - coupled with the perfect solution to meet your energy management and control needs.



Motor driven cable reels

Motor driven reels by Conductix-Wampfler are the perfect solution for managing long lengths of heavy cable and hoses in very demanding industrial applications. Monospiral, level wind, and random wind spoils.

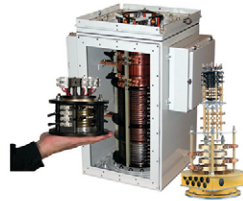

Slip ring assemblies

Whenever powered machinery needs to rotate 360°, field proven slip ring assemblies by Conductix-Wampfler can flawlessly transfer energy and data. Here, everything revolves around flexibility and reliability.



Conductor bar

Whether they are enclosed conductor rails, expandable single-pole bar systems, or high amperage bar for demanding steel mill use up to 6000 amps. Conductix-Wampfler's conductor bar is the proven solution to reliably move people and material.



Spring driven cable reels

We have 60 years experience and trusted brands such as Insul-8, Wampfler, and IER. We offer small cord reels all the way to large multi-motor units, a wide range of accessories, and hazardous location reels.



Cable Festoon systems

It's hard to imagine Conductix-Wampfler cable trolleys not being used in virtually every industrial application. They are reliable and robust and available in an enormous variety of sizes and models.



Push Button Pendants

Our ergonomic pendants are ideally suited for industrial control applications. They are available in a wide range of configurations for overhead cranes and other machinery.



Radio remote controls

Safe, secure, and reliable radios use the latest in microprocessor technology. Available in several models for overhead crane control and other types of machinery.



Inductive Power Transfer IPT®

The contact-less system for transferring energy and data. For all tasks that depend on high speeds and absolute resistance to wear.



Data Transfer: ProfiDAT® | Nexus

Safe & reliable wireless communication using slotted waveguide technology that's PROFIsafe compatible.

Nexus NB for narrow band signal transfer over power conductors



LJU Automation EMS Controller

Specialized controllers Programmable by parameters, Ideal for Electrified Monorails at automotive plants, with over 1500 in service worldwide. Adaptable for other applications



BridgeGuard™

Prevents crane to crane and crane to end collisions. IP69K rated for indoor and outdoor use, with a 3 ft to 150 ft range. Compliant with IEC 60068-2-6:2007



Air & Spring balancers | Air hoists

Conductix-Wampfler offers the full line of ENDO positioning devices. Rugged, reliable steel construction increasing safety and decreasing fatigue and body stress.

www.conductix.us

USA / LATIN AMERICA

10102 F Street
Omaha, NE 68127

Customer Support
Phone +1-800-521-4888

Phone +1-402-339-9300
Fax +1-402-339-9627

info.us@conductix.com
latinamerica@conductix.com

CANADA

1435 Norjohn Court
Unit 5
Burlington, ON L7L 0E6

Customer Support
Phone +1-800-667-2487

Phone +1-450-565-9900
Fax +1-450-951-8591

info.ca@conductix.com

MÉXICO

Calle Treviño 983-C
Zona Centro
Apodaca, NL México 66600

Customer Support
Phone (+52 81) 1090 9519
(+52 81) 1090 9025
(+52 81) 1090 9013

Fax (+52 81) 1090 9014

info.mx@conductix.com

BRAZIL

Rua Dois, 493
Itu, São Paulo, Brasil
CEP: 13312-820

Customer Support
Phone (+55 11) 4813 7330

Fax (+55 11) 4813 7330

info.br@conductix.com

Contact us for our Global Sales Offices

