

Cable Festoon Systems

C-Track | Stretch Wire Rope

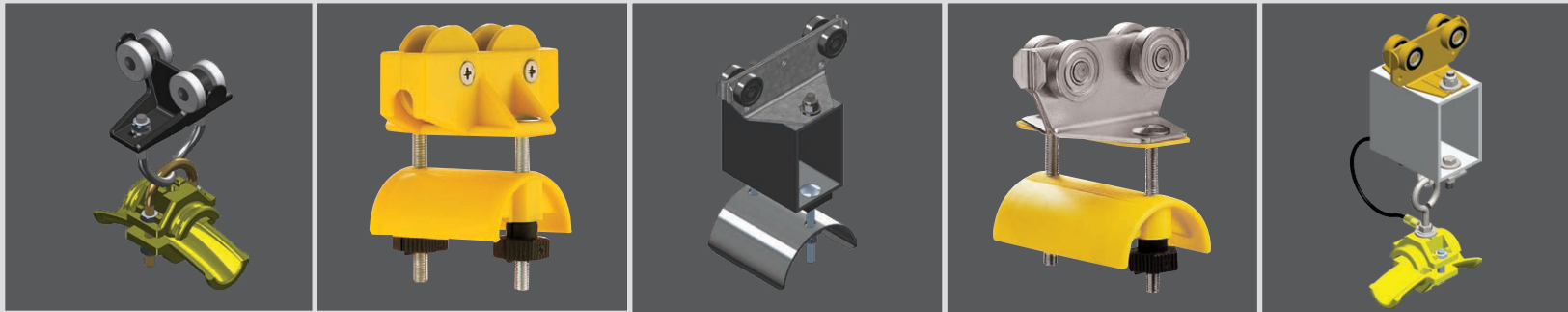

CONDUCTIX
wampfler

Contents

OVERVIEW			3
Festoon Specification Data Sheets			4-5
"Quick Quote Web" Software			6
C-Track Festoon Configurations			7
Flat Cable and Connectors			
	PVC Flat Cable	8	Cable Connectors for PVC Flat Cable 9
	Neoprene Flat Cable	10	Cable Connector for Neoprene Flat Cable 10
C-Track Festoon Mounting Styles			11
C-Track Systems, Standard Duty - 20-40 lb capacity per trolley, 130-250 fpm			
	General Layout Illustration	12	C-Track, Track Joint, Cross Arm Supports 13
	Cross Arm Brackets, Track Hangers	14	Track Hangers, Anchors, End Stop 15
	Flat Cable Trolleys, Tow Bar	16	Round Cable Trolleys, Tow Bar 17-18
	Control Unit Trolleys	19	
C-Track Systems, Heavy Duty - 70-80 lb capacity per trolley, 300-500 fpm			
	General Layout Illustration	20	Galvanized Track, Joint, Cross Arm Supports 21
	Galvanized Track, Hanger/Anchor, End Stop	22	Stainless Steel Track, Cross Arm Supports, Hanger 23
	Flat Cable Trolleys	24	Round Cable Trolleys 25
Stretch Wire Rope Festoon Kits - 10-20 lb per trolley, 200 fpm			
	For Flat Cable	26	For Round Cable or Hose 27
Junction Boxes			28
Push Button Pendants (Refer to catalog CAT1001 for details)			29
APPENDICES			
	Appendix I Crane Classes/NEMA Ratings	30	Appendix II Motor Current/Electrical Formulas 31
	Appendix III Round Cable Data	32	Appendix IV Metric Conversion Tables 33
	Appendix V Terms and Conditions	34	
Other Products by Conductix-Wampfler			35
Conductix-Wampfler Americas - Contact Information			36



C-Track and Stretch Wire Rope Festoon Systems

Conductix-Wampfler is the leading global manufacturer of high-performance cable festoon systems for supporting, protecting, and managing cables. We make them for hoses as well. Our festoon brands Conductix-Wampfler, Wampfler, and Insul 8 are used in demanding industrial applications all over the world. You can count on us to provide the right system for the job from among our several cable festoon lines.

C-Track Cable Festoon systems are suitable for standard overhead cranes, small gantry cranes, water treatment plants, car wash systems, plating lines, and many other types of moving equipment. Choose from a complete array of trolleys, track, cable, junction boxes, and connectors. Push button pendants or radio remote controls are available to operate your crane systems.

Our **Stretch Wire Rope Festoon** systems work well for lighter duty applications and installations where a C-Track cannot be installed.

Conductix-Wampfler **I-Beam Festoon** systems and **Square Bar Festoon** systems are ideal for very demanding environments, such as steel mills, bulk handling facilities, and for port container cranes. These are featured in the separate catalogs listed below.

If you don't see exactly what you need, contact us. We specialize in custom-engineered systems to match your application.

Conductix-Wampfler manufacturing facilities are ISO 9001:2008 certified and we are proud members of:



I-Beam Festoon Systems

Please refer to Conductix-Wampfler I-Beam Festoon System catalogs:

KAT0300-0101 I-Beam Engineering Guide

KAT0300-0001 I-Beam Festoon Overview

KAT0320-0001 I-Beam 314/320/325/330 Series

KAT0350-0001 I-Beam 350/360/364 Series

KAT0365-0001 I-Beam 365/370/375 Series

PBL7059 I-Beam 225 Series

C-Track Cable Festoon

C-Track Festoon is an economical and dependable system when the cable required can be supported by a "C" channel.

Heavy Duty C-Track features a heavier gauge track channel for higher capacity.



Preassembled C-Track Systems

Save time and money at the job site. Let our experienced personnel preassemble your C-track Cable Festoon system under ideal factory conditions. The complete system comes with cables already clamped to the trolleys at the specified loop depth and trolleys mounted to a C-track section. Installation is quick and easy - just hang the full length of track and transfer the system from the shipping track to the system track. Make your end connections, and you're done!



Stretch Wire Rope Festoon Kits

Stretch Wire systems are well suited for light duty applications. It is economical and dependable for small cranes, moving hoists, and other equipment.

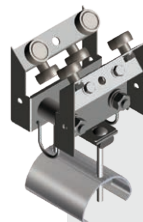
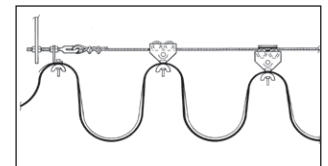

Square Bar Festoon Systems

Please refer to Conductix-Wampfler's 270 Series Festoon Catalog KAT0270-0001 for more information.

Festoon Specification Data Sheet

To choose the correct Festoon System, we recommend that you collect the following application data.

Request Date _____

Company _____

Company Type _____

Sales Person _____

Contact _____

Title _____

Tel _____

Fax _____

E-mail _____

System Parameters

Crane Type: _____

CMAA crane class _____

Travel Speed: _____ ft/min m/min

Acceleration: _____ ft/s² m/s²

Duty Cycle (hr/day): _____

Type of Festoon System(s) Required: Power Control
 Power & Control

Operating Conditions

Environment: Indoor Outdoor

Temperature Range: Min: _____ Max: _____ F° C°

Humidity (%): _____

Corrosives? (please list): _____

Hazardous Location? Yes No

Class, Division, Group: _____

Systems Dimensions

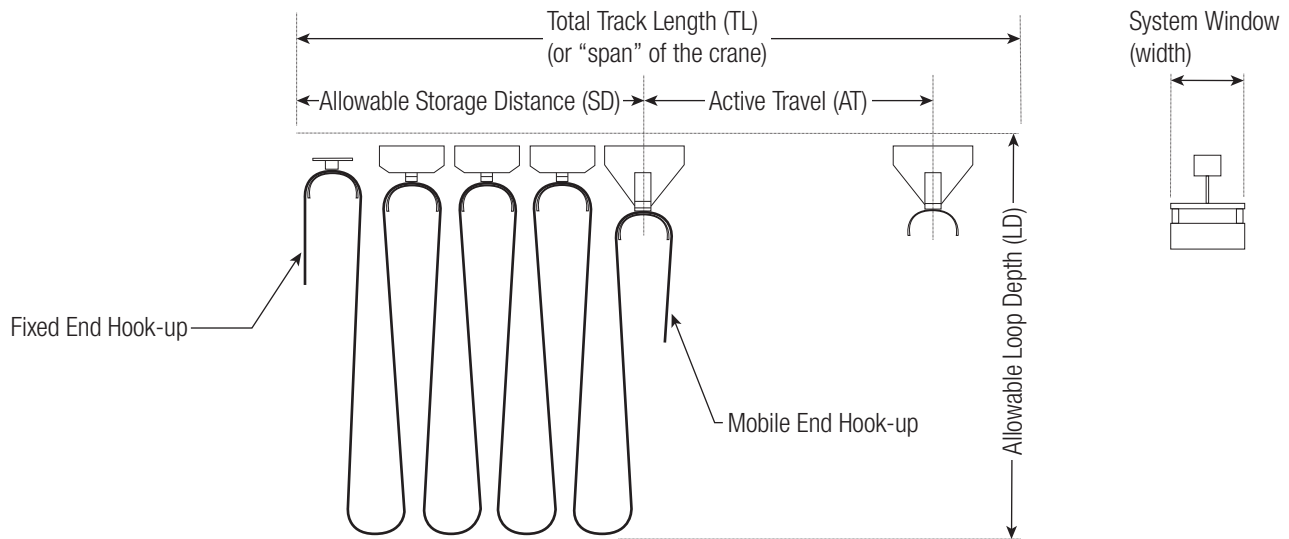

System Dimensions - Refer to drawing above.

TL: _____ ft. m System Window: _____ in. mm

AT: _____ ft. m Fixed End Hook-up: _____ in. mm

LD: _____ ft. m Mobile End Hook-up: _____ in. mm

SD: _____ ft. m Type of "Lead" Trolley Required: Tow Trolley Tow Clamp
 Control Trolley

Festoon Specification Data Sheet

Festoon Cable Requirement

Cable Specifications: Flat Round

Cable Jacket: Neoprene PVC

Item	Qty	Cable Type/Description	AWG	No of Cond.	Dimensions (in)	Weight (lb/ft)
1						
2						
3						
4						
5						
6						
7						
8						

Accessories/Options Required

Factory Pre-Assembly: Yes No

Cable Grips Needed: Yes No

Electrical J-Boxes Needed: Yes No J-Box NEMA Rating if required: _____

Factory Pre-Wiring, Fixed End: Yes No

Factory Pre-Wiring, Mobile End: Yes No

Control Trolley Needed: Yes, with J-Box Yes, without J-Box Yes, with Quick Disconnect No

Please detail any additional information below that might help specify the correct festoon system.

Phone: 800 521 4888 | 402 339 9300
 Fax: 800 780 8329 | 402 339 9627



“Quick Quote Web” Online System Quoting Program

Do you specify or purchase Conductor Bar Systems, Festoon Systems, or Push Button Pendants on a regular basis? If so, we recommend that you use our innovative **Quick Quote Web** online configuration tool. To access the program, all you need is a **Partners Site** login - see below.

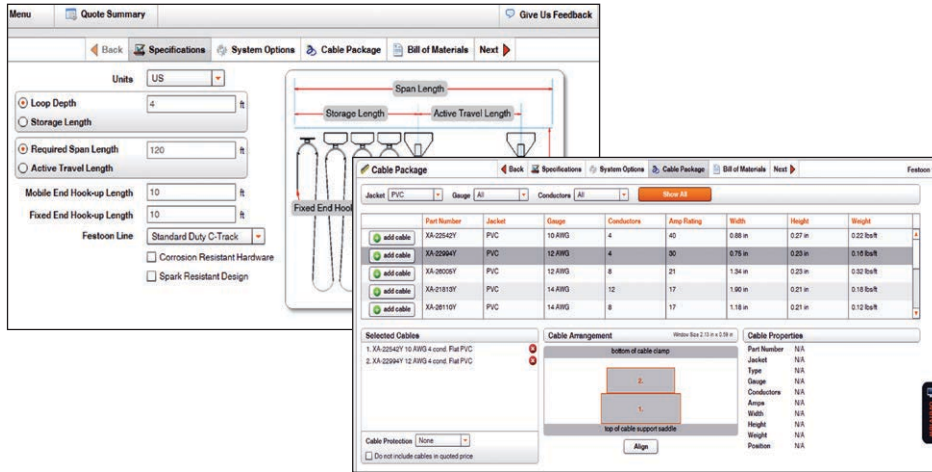

Quick Quote Web:

- Configures systems based on your needs and generates a bill of material
- Allows you to create and save customized quotes for your customers
- Enables you to transmit your quote to Conductix-Wampfler as an order, at the click of a button.

Advanced features for C-track and Square Bar Festoon Systems:

- Handles most common festoon mounting configurations
- Lets you set-up cable package arrangements and trolley selection
- Handles factory prewiring and preassembly options for festoon systems

Quick Quote Web allows you to add the appropriate Push Button Pendant:

- Determines the type of pendant required based on your cable festoon system parameters
- Allows you to choose pre-configured pendants and related accessories, including pendant cable

Quick Quote Web also specifies our most popular Conductor Bar Systems:

- Calculates crane amp draw with one or more vehicles
- Automatically calculates and graphs voltage drop with single or multiple power feed locations
- Handles advanced bar and collector mounting configurations
- Provides conductor bar system schematic



Our **Quick Quote Web** program is available on our **Partners Site** at

www.conductix.us

To access the program, you will need a Partners Site Login. Contact our Customer Service Team for details:

(+1) 800 521 4888 or (+1) 402 339 9300, Press 1.

Or by e-mail at customerservice@conductix.com

C-Track Festoon Installations

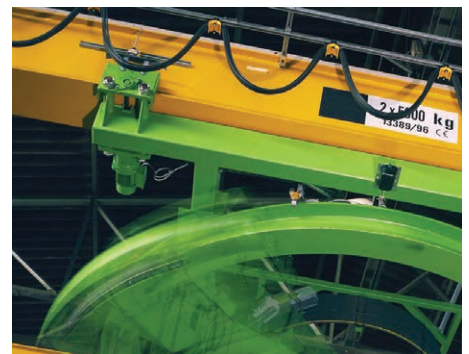
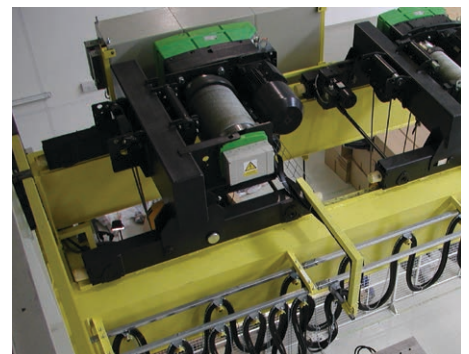
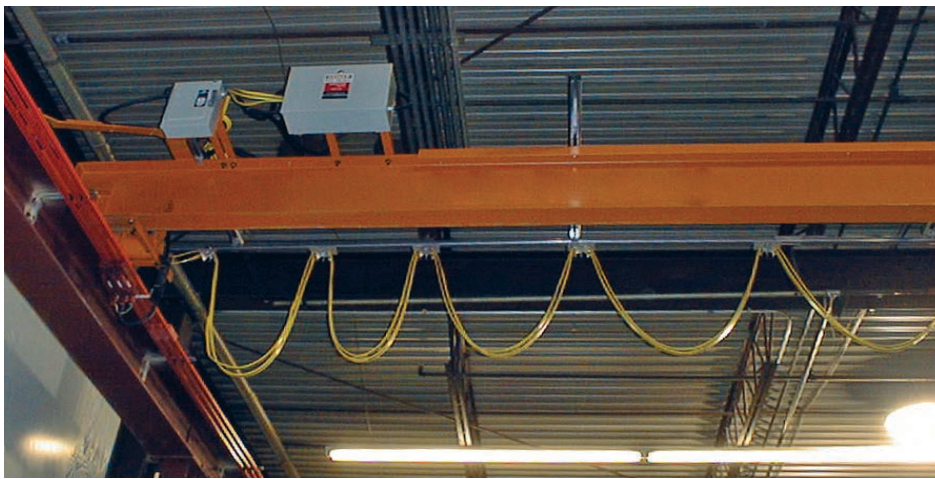
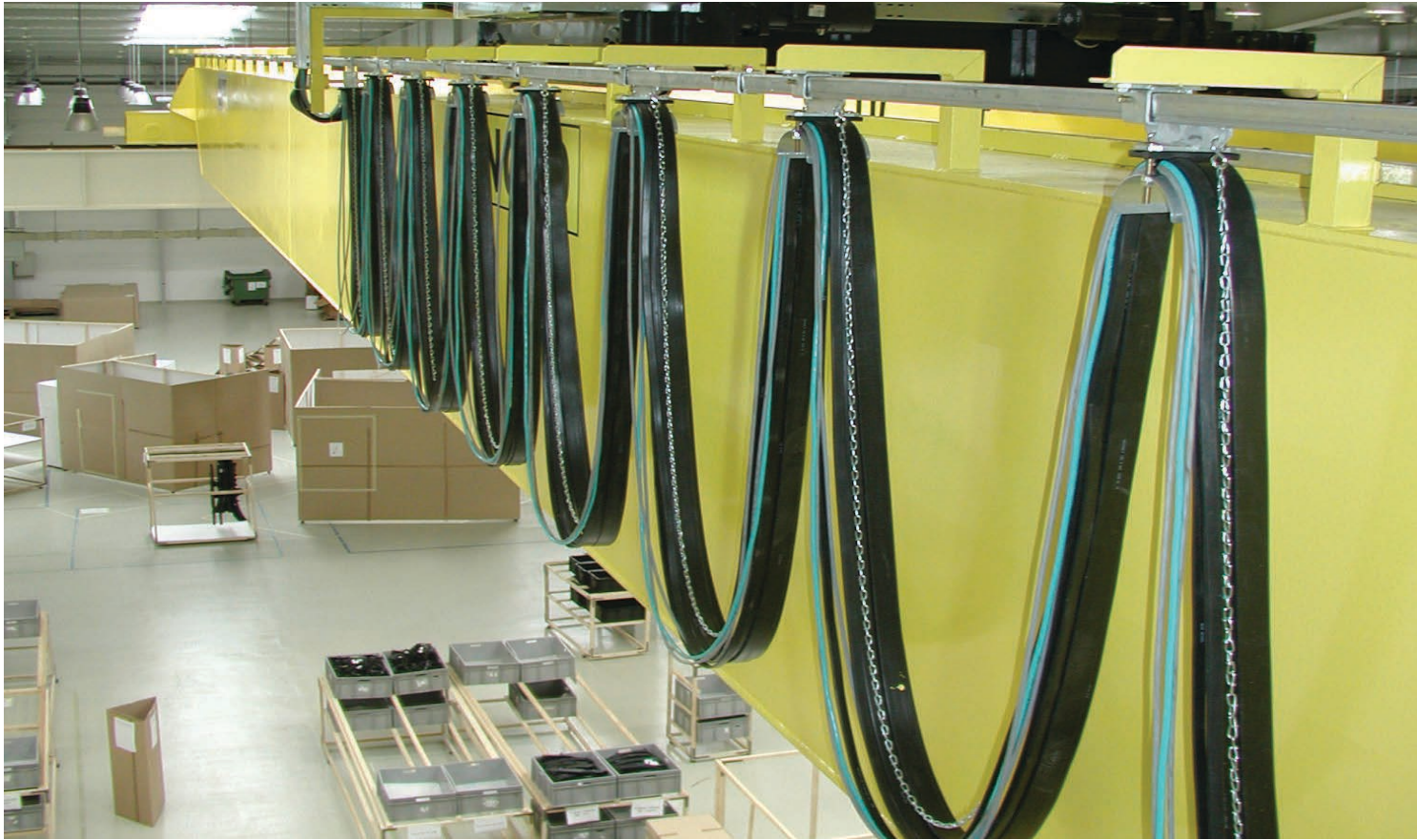

Flat cable is available in either yellow or black.

PVC Flat Cable

Standard flat cable has a yellow PVC jacket. Black cable jacket is also available by request - contact Conductix-Wampfler. Rip cords are provided with cables from 16 AWG to 10 AWG to assist with removing the outside jacket.

Flat cable is sold by the foot. To calculate required festoon cable length, add 10% to the track length, then add the desired hookup lengths for both fixed end and mobile end connections.

For Neoprene flat cables, see page 10. For Round Cables, see Pg. 32.

Cable Size		Part No.		Continuous Duty Rating (amps) *	Short Duration Rating (amps) **		Strands per Conductor	Unshielded Cable Nominal Dimensions +		Wt lb/ft (kg/m)
# of Cond	AWG	PVC Jacket	Shielded +		60 min	30 min		Height in. (mm)	Width in. (mm)	
4	2	23958Y		120	148	173	665	0.56 (14)	1.96 (50)	1.28 (1.90)
4	4	26550Y		90	111	130	420	0.49 (12)	1.66 (42)	0.88 (1.31)
4	6	21814Y		70	83	94	266	0.44 (11)	1.45 (37)	0.62 (0.92)
4	8	26698Y		50	63	69	168	0.37 (9)	1.19 (30)	0.40 (0.60)
4	10	22542Y		40	49	52	105	0.27 (7)	0.88 (22)	0.25 (0.37)
4	12	22994Y		30	36	40	65	0.23 (6)	0.71 (18)	0.17 (0.25)
4	14	21815Y		25	31	32	41	0.24 (6)	0.69 (17.5)	0.14 (0.21)
4	16	-	31734	n/a	n/a	n/a	65	0.24 (6)	0.76 (19)	0.16 (0.24)
8	12	26005Y		21	n/a	n/a	65	0.23 (6)	1.34 (34)	0.31 (0.46)
8	14	26110Y		17	n/a	n/a	41	0.24 (6)	1.33 (34)	0.26 (0.39)
8	16	22607Y	31772	15	n/a	n/a	65	0.20 (5)	1.11 (28)	0.18 (0.27)
12	14	21813Y	34819	17	n/a	n/a	41	0.24 (6)	1.95 (49.5)	0.36 (0.54)
12	16	23324Y	31580	15	n/a	n/a	65	0.20 (5)	1.61 (41)	0.26 (0.39)

NOTES:

* At 30° C (86° F) ambient temperature. Refer to correction factors in NEC Table 610.14 (A) for temperatures above 30°C.
PVC Cable is not suitable for festoon applications below -10° C

** For crane and hoist motors, in accordance with 2023 National Electric Code, Article 610 for 90° C cables

+ Dimensions may vary - contact Conductix-Wampfler

We sell flat cable in full spools as well as by the foot - contact the factory for details.

Cable Connectors - For Flat PVC Cable

Cable Connectors for Flat PVC Cable are used to terminate the cable at the power source or junction box. Connector has an aluminum body and rubber bushing. Some of the connectors listed have a dual slot to accommodate a second cable - see Cable # 2 columns below.



PN: 35835 (1" NPT, single slot)



PN: 35837 (1" NPT, dual slot)



PN: 35838 (2.0" NPT single slot)

Cable # 1			Cable # 2 (if required)			Connector	
No. of Cond.	AWG	Cable Part No. *	No. of Cond.	AWG	Cable Part No. *	NPT in. (mm)	Part No.
4	4	26550Y	-	-	-	2.0 (51)	35838
4	6	21814Y	-	-	-	2.0 (51)	35838B
4	8	26698Y	-	-	-	1.5 (38)	35837
4	10	22542Y	-	-	-	1.0 (25)	35835C
4	12	22994Y	-	-	-	1.0 (25)	35835B
4	14	21815Y	-	-	-	1.0 (25)	35835
8	12	26005Y	-	-	-	1.5 (38)	35837B
8	12	26005Y	8	12	26005Y	2.0 (51)	35838G
8	14	26110Y	-	-	-	1.5 (38)	35837C
8	14	26110Y	4	10	22542Y	1.5 (38)	35837K
8	14	26110Y	4	12	22994Y	1.5 (38)	35837M
8	14	26110Y	4	14	21815Y	1.5 (38)	35837H
8	14	26110Y	8	14	26110Y	1.5 (38)	35837E
8	16	22607Y	-	-	-	1.5 (38)	35837D
8	16	22607Y	4	10	22542Y	1.5 (38)	35837J
8	16	22607Y	4	12	22994Y	1.5 (38)	35837L
8	16	22607Y	4	14	21815Y	1.5 (38)	35837G
8	16	22607Y	8	16	22607Y	1.5 (38)	35837F
12	14	21813Y	-	-	-	2.5 (64)	605727
12	14	21813Y	4	10	22542Y	2.5 (64)	605931
12	14	21813Y	12	14	21813Y	2.5 (64)	605938
12	16	23324Y	-	-	-	2.0 (51)	35838D
12	16	23324Y	12	16	23324Y	2.0 (51)	35838F

* For details on PVC flat cables, see Pg. 8.

Heat Shrinkable Connectors For Flat or Round Cable

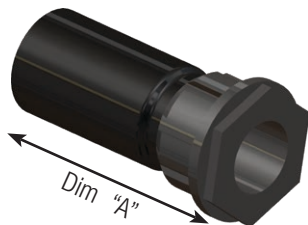

These connectors are for single cable and multiple cable groups and are corrosion resistant and flame retardant. They exceed US Navy requirements for tightness and integrity when used with one flat cable or multiple flat cables of the same size.

Cable Opening in. (mm)	Knockout Dia. in. (mm)	Part No.	Dimension "A"	Wt lb (kg)
1.60 (41)	2.00 (51)	03147	6.17 (157)	0.16 (0.07)
1.10 (28)	1.37 (35)	03146	4.50 (114)	0.16 (0.07)
0.75 (19)	1.00 (25)	03145	4.09 (104)	0.07 (0.03)

Neoprene Flat Cable

Neoprene Flat Cables are used for festoon systems when one or more of these conditions exist:

- The lateral and transverse motions of the host machine vary substantially.
- The cables will be exposed to oil.
- The minimum temperatures will be exceptionally low.

The Neoprene jacket is rated at -40° C to 90° C * and includes a UV inhibitor for outdoor use. The conductor insulation is ethylene propylene rubber (EPR) and rated at 90° C.

Conductix -Wampfler Part No.	Number of Cond.	Conductor Size AWG)	Stranding	Nominal Cable O.D. in (mm)	Minimum Bend Diameter in (mm)	Ampacity @ 40°C 1	Approximate Cable Weight Lbs/Mft (kg/Km)	Flat Cable Cord Grip
All-Temp (K) Flat Cable (600V)								
XA-579762	8	16	26/30	0.240 x 1.130 (6.1 x 28.7)	1.93 (49)	14	235 (350)	XA-35837C
XA-579765	12	16	26/30	0.240 x 1.662 (6.1 x 42.2)	1.93 (49)	14	340 (506)	XA-605727
XA-579766	4	14	41/30	0.288 x 0.792 (7.3 x 20.1)	2.32 (59)	18	185 (275)	XA-35835C
XA-579767	8	14	41/30	0.288 x 1.509 (7.3 x 38.3)	2.32 (59)	16	361 (537)	XA-35838B
XA-579768	12	14	41/30	0.288 x 2.226 (7.3 x 56.5)	2.32 (59)	16	526 (783)	XA-562447
XA-579769	4	12	65/30	0.310 x 0.880 (7.9 x 22.4)	2.52 (64)	23	240 (357)	XA-35837
XA-579770	8	12	65/30	0.320 x 1.695 (8.1 x 43.1)	2.56 (65)	20	463 (689)	XA-580527
XA-579771	12	12	65/30	0.320 x 2.500 (8.1 x 63.5)	2.56 (65)	20	707 (1052)	XA-580529
XA-579772	4	10	105/30	0.335 x 0.980 (8.5 x 24.9)	2.72 (69)	29	314 (467)	XA-35837
XA-579776	4	8	168/30	0.451 x 1.354 (11.5 x 4.3)	4.53 (115)	41	565 (841)	XA-35838B
XA-579777	4	6	266/30	0.485 x 1.490 (12.3 x 37.8)	4.85 (123)	55	728 (1083)	XA-35838
XA-579778	4	4	420/30	0.545 x 1.730 (13.8 x 43.9)	5.43 (138)	71	974 (1449)	XA-562685
XA-579779	4	2	665/30	0.608 x 1.982 (15.4 x 50.3)	6.06 (154)	95	1.442 (2146)	020612-20
XA-579780	4	1/0	1045/30	0.778 x 2.542 (19.8 x 64.6)	7.80 (198)	132	2.259 (3362)	020612-20
XA-579781	4	2/0	2107/30	0.824 x 2.726 (20.9 x 69.2)	8.23 (209)	149	2.702 (4021)	020612-202

Neoprene Flat Cable is available in cut lengths and in full spools. Contact the Factory.

Cable Connectors

Cable Connectors for Flat Neoprene Cable are used to terminate the cable at the power source or junction box. Connector has an aluminum body and rubber bushing.



# of cond	AWG	Cable Part No.	NPT Size (in)	Connector Part No.
4	2	XA-579779	2.50	XA-562685
4	4	XA-579778	2.50	XA-562685
4	6	XA-579777	2.00	XA-35838
4	8	XA-579776	1.50	XA-35838B
4	10	XA-579772	1.50	XA-562683
4	12	XA-579769	1.50	XA-35837
4	14	XA-579766	1.00	XA-35835C
8	14	XA-579767	2.00	XA-35838B
8	16	XA-579762	1.25	XA-35837
12	14	XA-579768	2.50	XA-562447
12	16	XA-579765	2.00	XA-35838

C-Track Festoon Mounting Styles

STYLE A Box Girder Crane - Control and Power Festoon on Opposite Sides

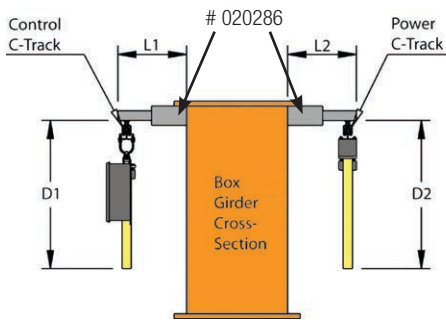

To quote this layout, we will need the information on Pg. 4-5, plus:

- Lengths L1 and L2, if Conductix-Wampfler is to supply the Cross Arm Support Channels (Pg. 13 and 21). These are attached with welded-on Suspension Support Brackets, 020286, Pg. 14.
- Maximum loop depths D1 and D2 from top of C-Track to the bottom of the loop

STYLE B I-Beam Crane - Control and Power Festoon on Opposite Sides

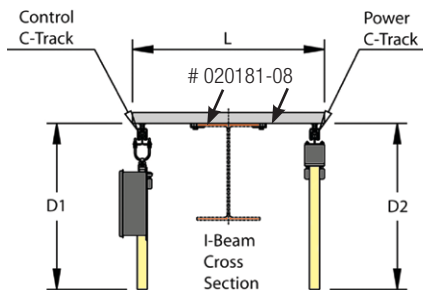

To quote this layout, we will need the information on Pg. 4-5, plus:

- Length L, if Conductix-Wampfler is to supply the Cross Arm Support Channels (Pg. 13 and 21). These are attached with Cross Arm Support Beam Clamps, 020181-08, see Pg. 14.
- Maximum loop depths D1 and D2 from top of C-Track to the bottom of the loop
- If a beam cap is present, the 020181-08 beam clamps will not work- contact Conductix-Wampfler for options.

STYLE C I-Beam Crane - Control and Power Festoon on Same Side, Clamped Cross Supports

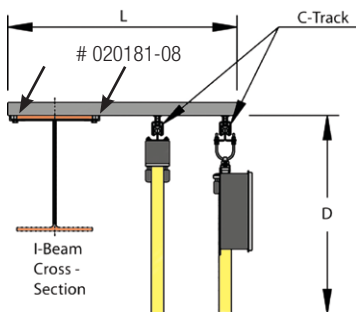

To quote this layout, we will need the information on Pg. 4-5, plus:

- Length L, if Conductix-Wampfler is to supply the Cross Arm Support Channels (Pgs. 13 and 21). These are attached with Cross Arm Support Beam Clamps, 020181-08, see Pg. 14.
- The maximum loop depth D from top of C-Track.
- If the I-beam has a cap, the 020181-08 beam clamps will not work- contact Conductix-Wampfler for options.

STYLE D I-Beam Crane - Control and Power Festoon on Same Side, Welded Cross Supports

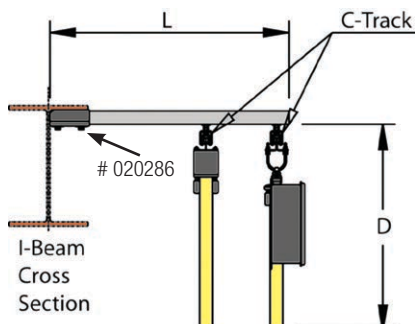

To quote this layout, we will need the information on Pg. 4-5, plus:

- Length L, if Conductix-Wampfler is to supply the Cross Arm Support Channels. These are attached with welded-on Suspension Support Bracket, 020286, Pg. 14.
- The maximum loop depth D from top of C-Track.

Standard Duty C-Track

The C-Track Festoon components needed for an overhead crane system depend upon how the system is to be mounted. Four typical mounting styles are shown on Pg. 11. The one shown below is "STYLE B". For all mounting styles, choose the types and lengths of cable (Pg. 8 and 10) using the formula (track length x 1.10) + hook-up lengths for both ends. For control systems, choose the type of control trolley you want - Junction Box or Quick-Disconnect - and whether you want to use a push button pendant (catalog CAT1001) or radio remote control (catalog CAT1002) to operate the crane. Please use the Specification Data Sheets on Pg. 4-5 to record your system parameters.

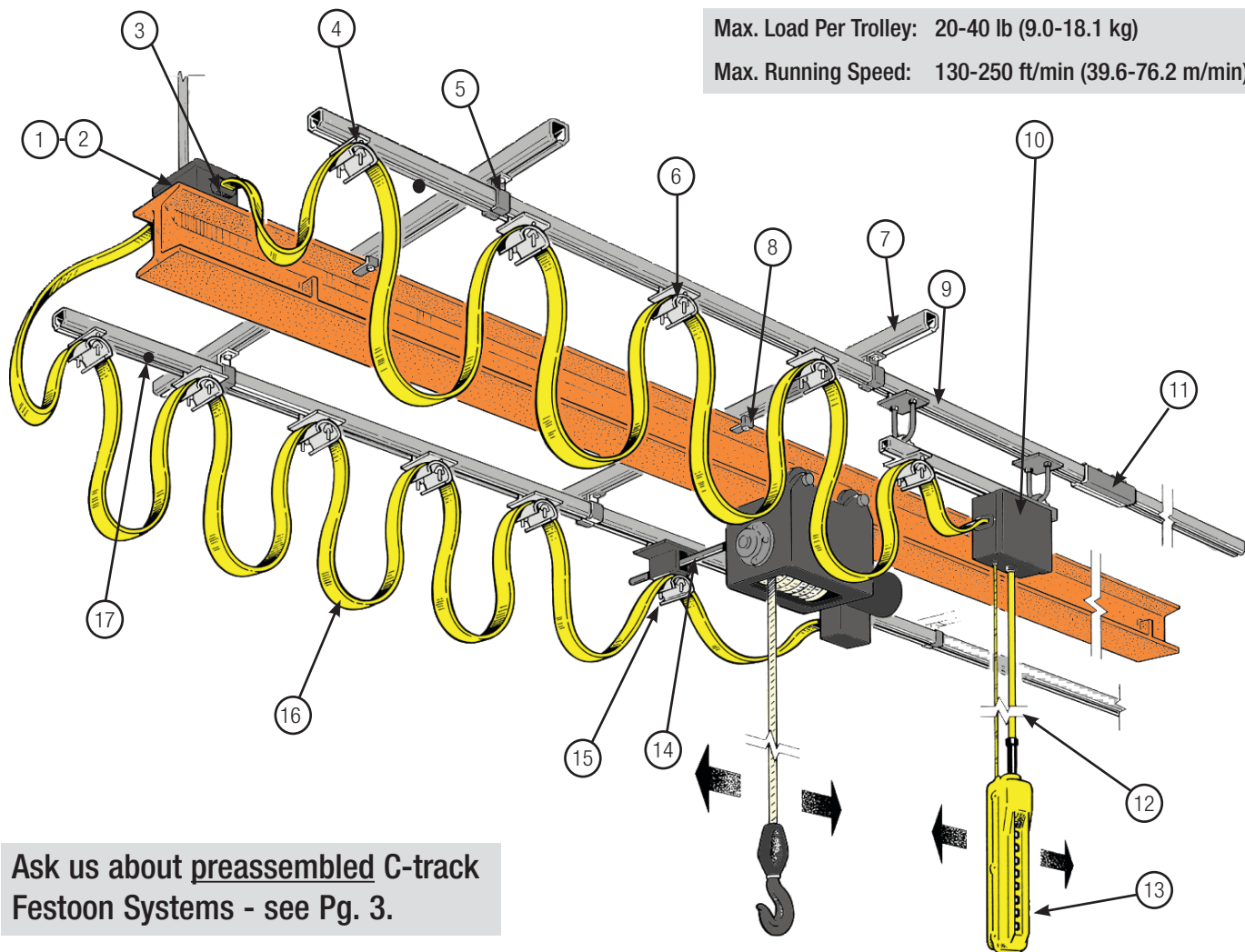

Ask us about preassembled C-track Festoon Systems - see Pg. 3.

- | | |
|---|--|
| <ul style="list-style-type: none"> ① Fixed End Junction Box ② Terminal Strips (inside junction box) ③ Cable Connectors ④ End Clamp ⑤ Track Hanger ⑥ Cable Trolley ⑦ Cross Arm Support Channels ⑧ Beam Clamp (for cross arm support channels) ⑨ C-Track Channel | <ul style="list-style-type: none"> ⑩ Control Unit Trolley with Junction Box; or Quick Disconnect Control Unit Trolley (not shown) ⑪ Track Joint Assembly ⑫ Pendant Cable ⑬ Push-Button Pendant Station ⑭ Tow Arm ⑮ Tow Trolley ⑯ Flat PVC Cable ⑰ End Stop |
|---|--|

Standard Duty C-Track - Track, Cross Arm Channels

C-Track



Galvanized steel shown

C-Track trolleys are designed to run in steel formed C-track sections. For curved track sections, please contact Conductix-Wampfler.

Available in either galvanized or stainless steel and in 10 and 20 foot lengths. Minimum curve radius: 48" (Galvanized) 72" (Stainless)

Channel Length ft (m)	Part No.		Wt lb (kg)
	Galvanized	Stainless	
10 (3.0)	530754	535633	8 (3.6)
20 (6.1)	534176	535634	15 (6.8)

End Caps



Black plastic end cap trim off the ends of the C-track sections above. Two required per run.

Part No.	Wt lb [kg]
020662-31	0.008 (0.004)

Clips With Cable Tie



Black plastic clip provides a way to tie cables to the C-track. Includes plastic cable tie. Order as many as needed.

Part No.	Wt lb [kg]
023790-1	0.02 (0.009)

Track Joint

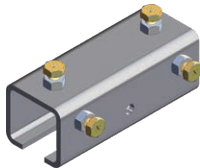

The bolted Track Joint securely connects track sections together end-to-end. One required at each track joint. Includes four bolts, lock washers, and nuts.

Part No.		Wt lb (kg)
Galvanized	Stainless	
023210	023410	0.65 (0.29)

Cross Arm Support Channels

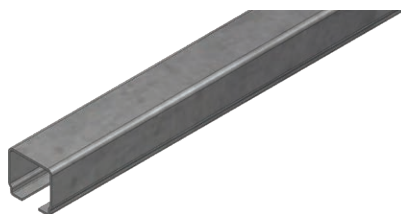

Cross Arm Support Channels are mounted perpendicular to the I-beam or girder every 5 ft to support the main C-track channel. See Pg. 11 for mounting options. Made from heavy channel for added rigidity.

Cross Arm Support Channels can be replaced by customer-supplied angle iron or other structural member sufficient to carry the total load of the festoon system. Make sure to order the correct hanger for the type of cross member used - see Pg. 14-15.

Length in. (mm)	Part No		Wt lb (kg)
	Galvanized	Stainless	
16.54 (420)	KC-020276-0420		2.20 (1.00)
25.59 (650)	020276-0650	534148B	3.25 (1.47)
39.37 (1000)	020276-1000	020475-1000	5.19 (2.35)
52.76 (1340)	020276-1340	534148	7.25 (3.29)
59.84 (1520)	020276-1520		8.00 (3.63)
70.87 (1800)	020276-1800		9.00 (4.08)
78.74 (2000)	020276-2000		6.56 (2.98)

Standard Duty C-Track - Track Hanger Brackets

Cross Arm Support Channel Beam Clamps



This clamp attaches Cross Arm Support Channels (Pg.13) to the I-beam flange - for Mounting Styles B or C - see Pg. 11. Two required per Cross Arm Support Channel.

Clamp bolt is an M8 x 50 mm long and will clamp to beam flange thicknesses between 0.24" and 0.98" (6 mm and 25 mm).

Part No.		Wt lb (kg)
Zinc Plated	Stainless Steel	
020181-08	534469	0.39 (0.18)

Suspension Support Bracket

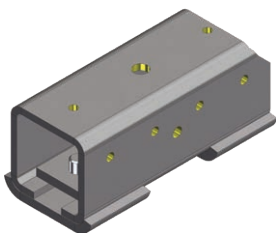

This bracket is welded to your runway beam, cross-bridge beam, or girder in the field to support the Cross Arm Support Channels when mounting styles A or D are preferred - see Pg. 11.

Galvanized finish only.

Part No.	Wt lb (kg)
020286	1.77 (0.80)

Track Hanger Brackets

To mount C-Track to Cross Arm Support Channels

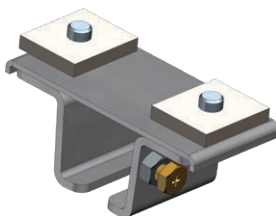

This bracket mounts to Cross Arm Support Channels (Pg. 13) at two points to hang the C-Track. The separate "Z" clamps allow mounting of the C-Track Channel without needing to feed it through the hangers from the end. The clamping action of the support bracket eliminates the need for a separate anchor.

Available in either galvanized or stainless steel finishes.

Part No.		
Galvanized	Stainless	Wt lb (kg)
023222-1	023422-1	0.53 (0.24)

Track Hanger Brackets

To mount C-Track to Angle Iron Cross Supports

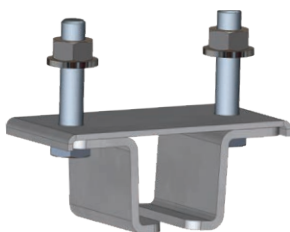

This bracket mounts to a customer-supplied angle iron at two points to hang the C-Track. The separate "Z" clamps allow mounting of the C-Track Channel without needing to feed it through the hangers from the end. The clamping action of the support bracket eliminates the need for a separate anchor.

Available in either galvanized or stainless steel finishes. Top bolts are M8 size and have an available length range between top of bracket and bottom of flat washer of 0.98" (20 mm).

Part No.		
Galvanized	Stainless	Wt lb (kg)
023223	023423-1	0.47 (0.21)

Standard Duty C-Track - Hangers/Anchors, End Stop

Track Hanger and Anchor

To mount C-Track to Cross Arm Support Channels

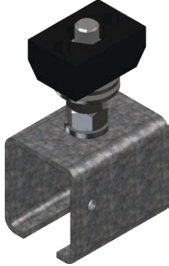

PN: 35707

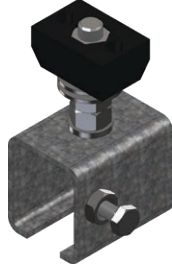

PN: 35706

A single-point hanger designed to hang C-Track (Pg. 13) from the Cross Arm Support Channels (also Pg. 13). One Hanger is required at each Cross Arm Support Channel for each track run. One of the Hangers (per run) should be replaced with an Anchor that has a set screw to keep the channel from sliding.

With this Hanger/Anchor style, the C-Track channel is fed through each Hanger from the end.

Type	Part No.		Wt lb (kg)
	Galvanized	Stainless	
Hanger	35707	50308	0.48 (0.22)
Anchor	35706	50307	0.47 (0.21)

Track Hanger and Anchor

To mount C-Track to Angle Iron Cross Arms

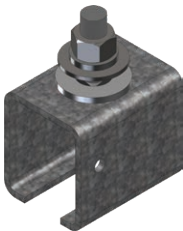

PN: 28510

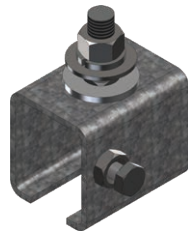

PN: 28511

A single-bolt hanger design to support C-Track from customer-supplied angle iron cross supports. One "hanger" required at each support channel for each track run. Replace one of the Hangers per run with an Anchor that has a set screw to keep the channel from sliding.

With this Hanger/Anchor style, the C-Track channel is fed through each Hanger from the end.

Top bolts are 3/8-16 x 1 1/4" long.

Type	Part No.		Wt lb (kg)
	Galvanized	Stainless	
Hanger	28510	28741	0.43 (0.20)
Anchor	28511	28742	0.42 (0.19)

End Stop

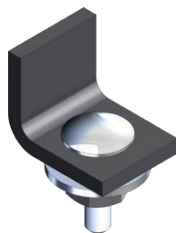

PN: 023215

One required for power system, two required for control systems with control trolley.

Part No.		Wt lb (kg)
Galvanized	Stainless	
023215	27727	0.13 (0.06)

Standard Duty C-Track - Flat Cable Trolleys, Tow Bar

These trolleys accommodate **Flat Cable** - see Pg. 8 and 10. For round cable/hose trolleys, see Pg. 17-18.

Max. Load Per Trolley: 20-40 lb (9.0-18.1 kg)
Max. Running Speed: 130-250 ft/min (39.6-76.2 m/min)

Tow Trolley

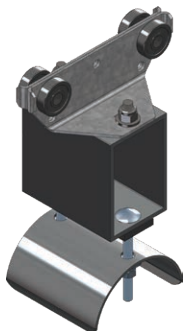

PN: 22168

One Tow Trolley is required for each track run. The unit has an opening in the body to accommodate the Tow Bar - see below. Stainless steel trolleys have stainless steel body/saddle and stainless steel sealed rollers and hardware. Spark-resistant trolley designs are available for hazardous locations.

Style (cap. lb)	Saddle in (mm)		Part No.	Wt lb (kg)
	Dia	Width		
Plastic body/saddle (20)	2.00 (51)	3.0 (76)	28614	0.78 (0.35)
Plated Steel (40)	2.75 (70)	3.0 (76)	22168	1.49 (0.68)
Stainless Steel (40)	2.75 (70)	3.0 (76)	39274	1.12 (0.51)
Spark Resistant/Brass (40)	2.75 (70)	3.0 (76)	37042	1.49 (0.68)

Tow Bar



Tow Bar mounts on the moving equipment to move the festoon system. One required for each Tow Trolley. Square bar is 16" long.

Part No.	Metal Type	Post Size in (mm)	Wt lb (kg)
39618	Plated Steel	0.50 (12.7)	1.56 (0.71)
50142	Stainless Steel	1.0 (25.4)	2.63 (1.19)

Cable Trolleys



PN: 023571



PN: 39227

A Cable Trolley is required for each flat cable loop between the End Clamp and Tow Trolley. Stainless steel trolleys have stainless steel body/saddle and stainless steel sealed rollers and hardware. Spark-resistant trolleys are available for hazardous locations.

Style (cap. lb)	Saddle in. (mm)		Part No.	Wt lb (kg)
	Dia	Width		
Plastic Body/Saddle (20)	2.00 (51)	3.0 (76)	023941	0.40 (0.18)
Steel Body/Plastic Saddle (20)	2.00 (51)	3.0 (76)	023261	0.52 (0.24)
Plated Steel (40)	2.75 (70)	3.0 (76)	21991	0.80 (0.36)
Stainless Steel (40)	3.00 (76)	3.0 (76)	39227	0.70 (0.32)
Spark Resistant/Brass (40)	2.75 (70)	3.0 (76)	37047	1.06 (0.48)
Plated Steel - 5" Body (40)	2.75 (70)	3.0 (76)	023571	1.06 (0.48)
Stainless Steel - 5" Body (40)	2.75 (70)	3.0 (76)	39275	0.97 (0.44)

End Clamps

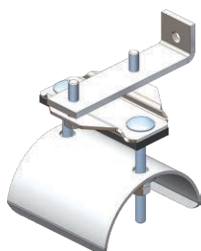

PN: KC-023579/551

One End Clamp is required at the fixed end of the system. Includes clamp and hardware to secure the cable.

Style (cap. lb)	Saddle in. (mm)		Part No.	Wt lb (kg)
	Dia	Width		
Steel Body/Plastic Saddle (20)	2.00 (51)	3.0 (76)	KC-023269/551	0.50 (0.23)
Plated Steel (40)	2.75 (70)	3.0 (76)	21957	0.64 (0.29)
Plated Steel (40)	3.00 (76)	3.0 (76)	KC-023579/551	0.64 (0.29)
Stainless Steel (40)	2.75 (70)	3.0 (76)	39226	0.56 (0.25)

Standard Duty C-Track - Round Cable Trolleys

Round Cable Trolleys are used to carry round cables or hoses. A Tow Trolley is used at the mobile end, an End Clamp at the fixed end, and Cable Trolleys at each cable loop between. The trolleys have four rollers with shielded ball bearings. Stainless steel version has stainless steel body, saddle, sealed rollers, and hardware. Spark-resistant trolleys designs are available for hazardous locations - Contact Conductix-Wampfler.

For Round Cables - see Pg. 32

Max. Load Per Trolley: 20-40 lb (9.0-18.1 kg)
Max. Running Speed: 130-250 ft/min (39.6-76.2 m/min)

Tow Trolley



PN: 50591

One Tow Trolley is required for each track run. The unit has an opening in the body to accommodate the Tow Bar - see below. Stainless steel trolleys have stainless steel body, stainless steel sealed rollers, and stainless steel hardware. Spark-resistant trolleys designs are available for hazardous locations.

Max. Cable Dia. in. (mm)	Style (cap. lb)	Part No.	Wt lb (kg)
0.63 (16)	Plastic (20)	35741	0.70 (0.32)
0.63 (16)	Plated Steel (40)	35744	1.12 (0.51)
0.63 (16)	Stainless Steel (40)	51214B	1.12 (0.51)
0.63 (16)	Spark Resistant/Brass (40)	50591B	1.12 (0.51)
0.98 (25)	Plastic (20)	35488	0.74 (0.34)
0.98 (25)	Plated Steel (40)	35494	1.16 (0.53)
0.98 (25)	Stainless Steel (40)	51214	1.16 (0.53)
0.98 (25)	Spark Resistant/Brass (40)	50591	1.16 (0.53)
1.42 (36)	Plastic (20)	35491	0.87 (0.38)
1.42 (36)	Plated Steel (40)	35495	1.29 (0.57)
1.42 (36)	Stainless Steel (40)	51214C	1.29 (0.57)
1.42 (36)	Spark Resistant/Brass (40)	50591C	1.29 (0.57)

Tow Bar



Tow Bar mounts on moving equipment to move the festoon system. One required for each Tow Trolley. Square bar is 16" long.

Part No.	Metal Type	Post Size in (mm)	Wt lb (kg)
39618	Plated Steel	0.50 (12.7)	1.56 (0.71)
50142	Stainless Steel	1.0 (25.4)	2.63 (1.19)

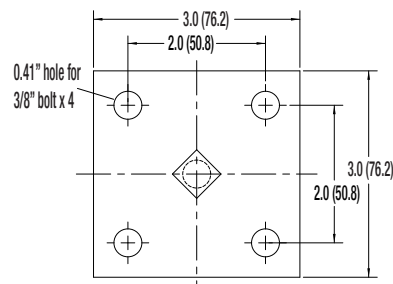

Standard Duty C-Track - Round Cable Trolleys

Cable Trolleys

A Cable Trolley is required for each cable loop between the End Clamp and Tow Trolley. Stainless steel trolleys have stainless steel body, stainless steel sealed rollers, and stainless steel hardware.

Spark-resistant trolleys designs are available for hazardous locations.

For Round Cables - see Pg. 32

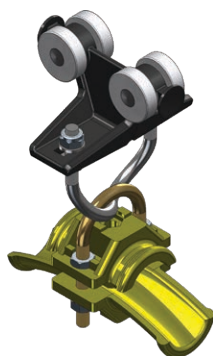

PN: 35487



PN: 50589

Max. Cable Dia. in. (mm)	Style (cap. lb)	Part No.	Wt lb (kg)
0.63 (16)	Plastic (20)	35740	0.41 (0.19)
0.63 (16)	Plated Steel (40)	35743	0.70 (0.32)
0.63 (16)	Stainless Steel (40)	51216B	0.70 (0.32)
0.63 (16)	Spark Resistant/Brass (40)	50589B	0.70 (0.32)
0.98 (25)	Plastic (20)	35487	1.56 (0.71)
0.98 (25)	Plated Steel (40)	35496	0.74 (0.34)
0.98 (25)	Stainless Steel (40)	51216	0.74 (0.34)
0.98 (25)	Spark Resistant/Brass (40)	50589	0.74 (0.34)
1.42 (36)	Plastic (20)	35490	0.57 (0.26)
1.42 (36)	Plated Steel (40)	35497	0.87 (0.40)
1.42 (36)	Stainless Steel (40)	51216C	0.87 (0.40)
1.42 (36)	Spark Resistant/Brass (40)	50589C	0.87 (0.40)

End Clamps

One End Clamp is required at the fixed end of the system.

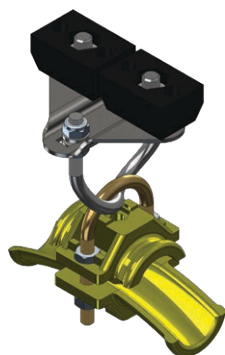

PN: 35489



PN: 50590

Max. Cable Dia. in. (mm)	Style (cap. lb)	Part No.	Wt lb (kg)
0.63 (16)	Plated Steel (40)	35742	0.56 (0.25)
0.63 (16)	Stainless Steel (40)	51215B	0.56 (0.25)
0.63 (16)	Spark Resistant (40)	50590B	0.56 (0.25)
0.98 (25)	Plated Steel (40)	35489	0.60 (0.27)
0.98 (25)	Stainless Steel (40)	51215	0.60 (0.27)
0.98 (25)	Spark Resistant (40)	50590	0.60 (0.27)
1.42 (36)	Plated Steel (40)	35492	0.73 (0.33)
1.42 (36)	Stainless Steel (40)	51215C	0.73 (0.33)
1.42 (36)	Spark Resistant (40)	50590C	0.73 (0.33)

Standard Duty C-Track - Control Unit Trolleys

J-Box Control Unit Trolley

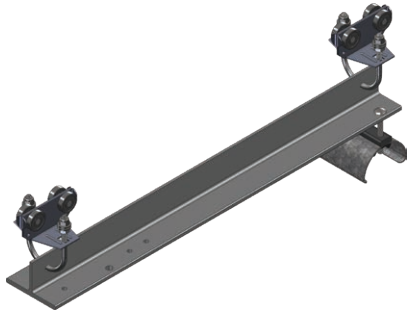

The Control Unit Trolley accommodates a control junction box, ordered separately, see Pg. 28. One flat cable saddle and two trolleys are suspended from a steel “T” section. Unit includes hardware to attach the junction box to the bracket.

Stainless steel version has stainless steel body and saddle, with stainless steel sealed rollers and hardware.

For hazardous locations, trolleys with spark-resistant bronze rollers are available - Contact Conductix-Wampfler.

Style	Saddle Dia in. (mm)	Part No.	Wt lb (kg)
Plated Steel	2.75 (70)	22203B	3.70 (1.68)
Stainless Steel	2.75 (70)	32166	3.00 (1.36)

Quick Disconnect Control Unit Trolley

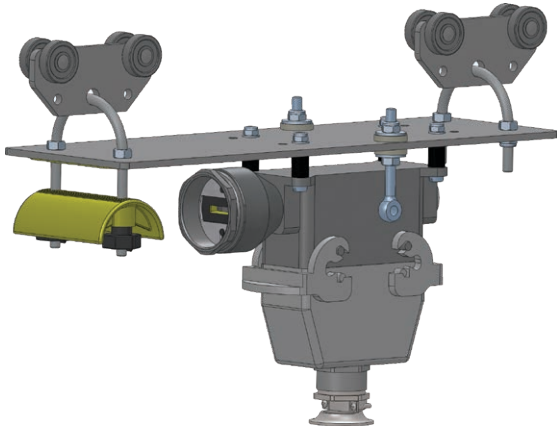

Push Button Pendants working in tough industrial environments could easily be damaged. Rewiring a replacement pendant adds downtime and risk to personnel. The solution is the “Quick Disconnect” Pin Connector set, which is included with this style of Control Unit Trolley.

The connector set includes a positive latch mechanism to keep the pendant plugged in until you’re ready to disconnect it. The upper half of the connector accepts the incoming flat cable; the lower half accepts the pendant cable. Pendants are ordered separately - see CAT1001. Trolley and hardware are zinc plated.

Connector Electrical Rating: 16A maximum, 600 VAC

No. of Connector Pins	Saddle Dia in. (mm)	Part No.	Wt lb (kg)
16	2.75 (70)	KC-023178-16/554	5.28 (2.39)
24	2.75 (70)	KC-023178-24/554	5.59 (2.54)

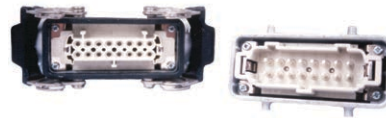

Close-up of Pin Connector Set



Quick Disconnects are commonly used with pendants, as shown at the far left, but they can also be used with radio controls. This allows a quick switch from radio control to a standard pendant.

Contact Conductix-Wampfler for more information about the possible uses for the Quick Disconnect.

We offer many styles of pin connectors and junction box configurations to suit your individual needs - Contact Conductix-Wampfler at 1-800-521-4888 (Press 2 for Inside Sales) for details. For Junction Boxes and Terminal Strips, See Pg. 28.

Heavy Duty C-Track

To handle heavier cable loads and faster speeds, Heavy Duty C-Track features a thicker walled track versus Standard Duty C-Track. Order the appropriate HD C-Track components to assure they will fit the heavier track. The components needed for a system depend upon how the system is to be mounted - see Pg. 11 for examples. The system below is a "STYLE B" setup. For all mounting styles, choose the types and lengths of cable (Pgs. 8 & 10) using the formula (track length x 1.10) + hook-up lengths for both ends. Please use the Specification Data Sheets on Pg. 4-5 to record your system parameters.

Max. Load Per Trolley: 70-80 lb (31.75-36.29 kg)
Max. Running Speed: 300-500 ft/min (91.4-152.4 m/min)

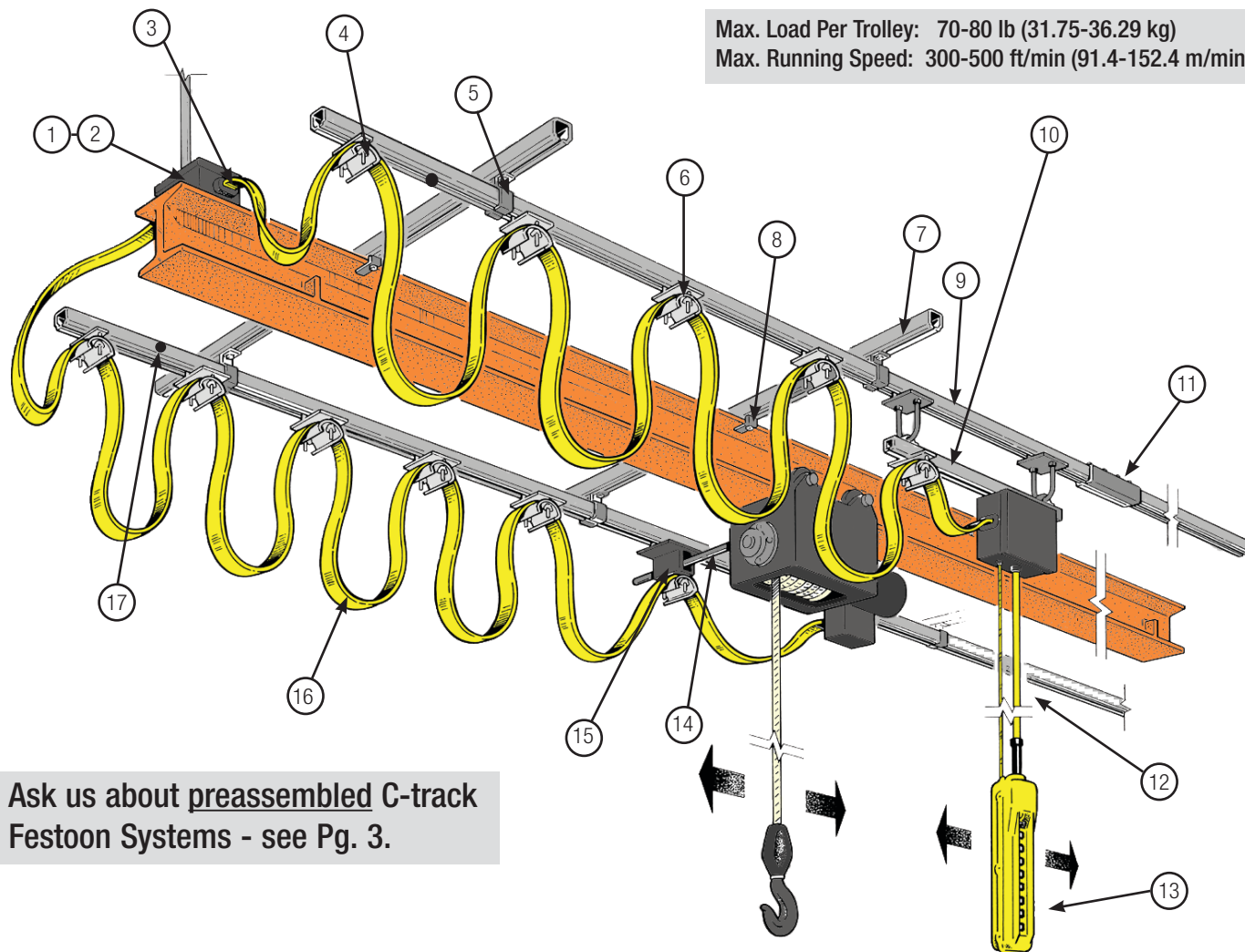

Ask us about preassembled C-track Festoon Systems - see Pg. 3.

- | | |
|---|---|
| ① Fixed End Junction Box | ⑩ Control Unit Trolley with Junction Box - or Quick Disconnect Control Unit Trolley (not shown) |
| ② Terminal Strips (inside junction box) | ⑪ Track Joint |
| ③ Flat Cable Connector | ⑫ Pendant Cable |
| ④ End Clamp | ⑬ Push Button Pendant |
| ⑤ Track Hanger | ⑭ Tow Arm |
| ⑥ Cable Trolley | ⑮ Tow Trolley |
| ⑦ Cross Arm Support Channels | ⑯ Flat PVC Cable |
| ⑧ Beam Clamp (for Cross Arm Channels) | ⑰ End Stop |
| ⑨ C-Track Channel | |

Heavy Duty C-Track - Galvanized Track and Fittings

C-Track

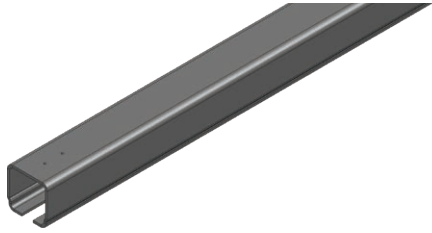

Heavy Duty galvanized track channel sections accommodate all the trolleys listed on Pgs. 24-25 except the stainless steel trolleys. For stainless steel C-track, see Pg. 23.

Channel Length ft (m)	Part No. Galvanized	Wt lb (kg)
10 (3.0)	22210	18.26 (8.28)
20 (6.1)	21805	38.0 (17.24)

Track Joint



The galvanized Track Joint securely bolt track sections end-to-end. One required between each track joint. Includes four bolts, lock washers, and nuts.

Works only with track part numbers 22210 and 21805.

Part No.	Wt lb (kg)
21806	1.1 (0.50)

Cross Arm Support Channels

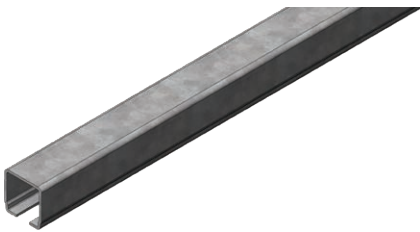

These channels are mounted perpendicular to the I-beam or girder every 10 ft to support the main C-track channel - see Pg. 11 for examples of mounting options.

Cross Arm Support Channels can be replaced by customer-supplied angle iron or other structural member sufficient to carry the total load of the festoon system. Make sure to order the correct hanger for the type of cross member used - see Pg. 22-23.

Length in. (mm)	Part No. Galvanized	Wt lb (kg)
16.54 (420)	KC-020276-0420	2.20 (1.00)
25.59 (650)	020276-0650	3.00 (1.36)
52.76 (1340)	020276-1340	7.25 (3.29)
59.84 (1520)	020276-1520	8.00 (3.63)
70.87 (1800)	020276-1800	9.00 (4.08)
78.74 (2000)	020276-2000	6.56 (2.98)

Heavy Duty C-Track - Galvanized Hangers, End Stop

Track Hanger and Anchor

To mount C-Track to Cross Arm Support Channels

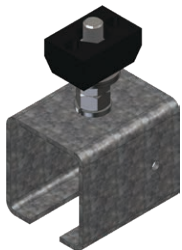

PN: 37465

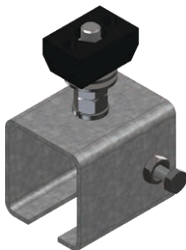

PN: 37466

A single-point hanger designed to hang Heavy Duty C-Track (Pg. 21) from the Cross Arm Support Channels (Pg. 21). One Hanger is required at each Cross Arm Support Channel for each track run. One of the Hangers (per run) should be replaced with an anchor. The anchor has a set screw to keep the channel from sliding.

With this style Hanger/Anchor, the C-Track is feed through each Hanger from the end.

Type	Part No. Galvanized	Wt lb (kg)
Hanger	37465	0.51 (0.23)
Anchor	37466	0.45 (0.021)

Track Hanger and Anchor

To mount C-Track to Angle Iron Cross Arms

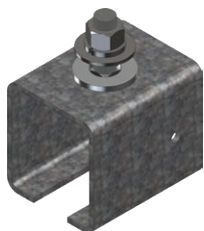

PN: 28512

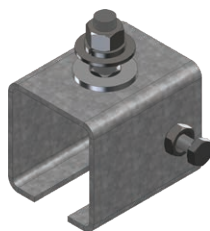

PN: 28513

A single-bolt hanger designed to support Heavy Duty C-Track from customer-supplied angle iron cross supports. One "hanger" required at each support angle for each track run. One of the Hangers (per run) should be replaced with an Anchor that has a set screw to keep the channel from sliding.

With this style Hanger/Anchor, the C-Track channel is feed through each Hanger from the end.

Top carriage bolts are 3/8"-16 x 1 1/4" long.

Type	Part No. Galvanized	Wt lb (kg)
Hanger	28512	0.58 (0.26)
Anchor	28513	0.45 (0.21)

End Stop

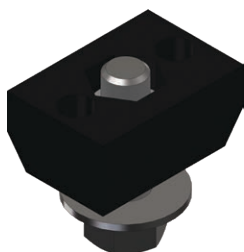

One required for per system at storage end of track.

Part No. Galvanized	Wt lb (kg)
28508	0.20 (0.09)

Heavy Duty C-Track - Stainless Steel Track and Fittings

Stainless Steel Heavy Duty C-Track

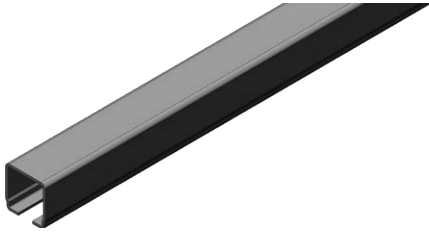

Heavy Duty stainless steel C-Track sections are available in either 13.12 ft (4 meter) or 19.68 ft (6 meter) lengths.

This track only works with the 024186 stainless steel Track Joint shown below, and the stainless steel trolleys shown on Pg. 24.

Channel Length ft (m)	Part No.	Wt lb (kg)
13.12 (4.0)	024109-4	20.0 (9.07)
19.68 (6.0)	024109-6	40.0 (10.14)

Stainless Steel Track Joint

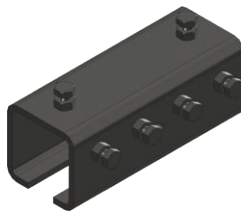

Stainless steel Track Joint securely joins and properly aligns stainless steel track sections. One required between each track joint. Includes four bolts, lock washers, and nuts. Works only with stainless steel HD C-track 024109-4 and 024109-6.

Type	Part No.	Wt lb (kg)
Stainless	024186	1.54 (0.70)

Stainless Steel Cross-arm Support Channel

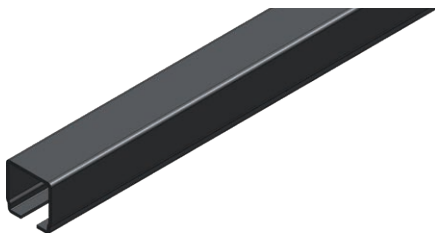

Mounted perpendicular to the I-beam or girder every 5 ft to support the stainless steel C-track (see above). See Pg. 11 for system mounting examples.

Cross Arm Support Channels can be replaced by customer-supplied angle iron or other structural member sufficient to carry the total load of the festoon system. Make sure to order the correct hanger for the type of cross member used.

Length in. (mm)	Part No. Stainless Steel	Wt lb (kg)
25.59 (650)	534148B	3.25 (1.47)
39.37 (1000)	020475-1000	3.28 (1.49)
52.76 (1340)	534148	4.40 (2.00)

Stainless Steel Track Hanger

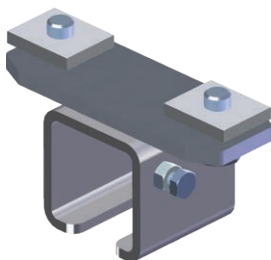

PN: 024192

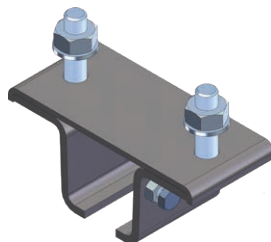

PN: 024177

A stainless steel two-point hanger designed to support stainless steel C-Track Channels from either the cross support above or from customer supplied cross members. One "hanger" required at each support channel for each track run.

The C-Track is feed through the 024192 Hanger from the end. The "Z" clamps on the 024177 hanger allows the C-track to be insert from the side of the bracket.

024177 mounting bolts are M8 and handle material thicknesses of up to 20 mm.

Part No.		Wt lb (kg)
For Cross Arm Channel	For Angle Iron	
024192	024177	0.51 (0.23)

** Only for 024109 track shown above

Heavy Duty C-Track - Flat Cable Trolleys

Stainless Steel Heavy Duty C-Track Trolleys only run in the Stainless Steel Heavy Duty C-Track (PN: 024109-4 and 024109-6, see Pg. 23.)

Max. Load Per Trolley: 70-80 lb (31.75-36.29 kg)
Max. Running Speed: 300-500 ft/min (91.4-152.4 m/min)

Tow Trolley

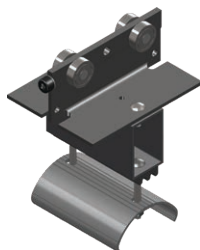

PN: 22169

One Tow Trolley is required for each flat cable run. The unit has an opening in the body to accommodate the Tow Bar - see Pg. 25. Aluminum style has aluminum body and saddle. Stainless steel trolleys have stainless steel body/saddle, stainless steel sealed rollers, and stainless steel hardware.

Style (cap lb)	Saddle in. (mm)		Part No.	Wt lb (kg)
	Dia	Width		
Aluminum (80)	2.75 (70)	3.0 (76)	38646	1.90 (0.86)
Aluminum (80)	4.0 (102)	5.0 (127)	22169	4.75 (2.15)
Stainless Steel (70)	5.0 (127)	7.0 (180)	024822-200x160	6.0 (2.72)

Control Unit Trolley for J-Box

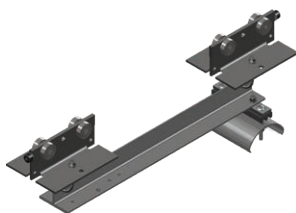

Two trolleys and one 4" (102 mm) diameter aluminum saddle for flat cable, mounted on a 22" (559 mm) long galvanized or stainless steel bracket. Includes fittings to attach control box. Junction box sold separately - see Pg. 28.

Style	Part No.	Wt lb (kg)
Galvanized Steel	22350	12.5 (5.67)
Stainless Steel	024107-NB-SS	12.5 (5.67)

Cable Trolley

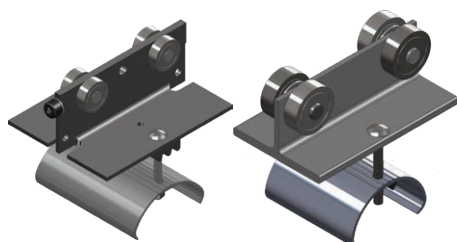

PN: 21802

PN: 38641

A Cable Trolley is required for each flat cable loop between the End Clamp and Tow Trolley. Aluminum style has aluminum body and saddle. Stainless steel trolleys have stainless steel body/saddle and stainless steel sealed rollers and hardware.

Style (cap. lb)	Saddle in. (mm)		Part No.	Wt lb (kg)
	Dia	Width		
Aluminum (80)	2.75 (70)	3.0 (76)	38641	1.49 (0.68)
Aluminum (80)	4.0 (102)	5.0 (127)	21802	2.45 (1.11)
Stainless Steel (70)	5.0 (127)	6.3 (160)	024812-160x160	4.00 (1.81)

End Clamp

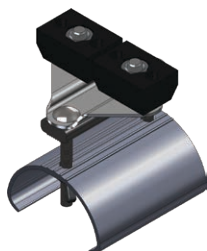

PN: 24767

One End Clamp is required at the fixed end of the system. Includes zinc plated clamp and hardware to secure the cable. Stainless steel end clamp has stainless steel saddle and hardware.

Style (cap. lb)	Saddle in. (mm)		Part No.	Wt lb (kg)
	Dia	Width		
Aluminum (80)	2.75 (70)	3.0 (76)	24767	0.49 (0.22)
Aluminum (80)	4.0 (102)	5.0 (127)	21932	1.34 (0.61)
Stainless Steel (70)	5.0 (127)	6.3 (160)	024832-160x062	2.0 (0.90)

Heavy Duty C-Track - Round Cable/Hose Trolleys

Tow Trolley

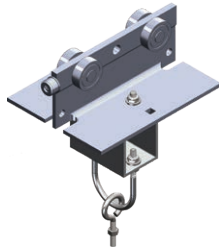

One Tow Trolley is required for each track run and has a cutout in the body to accommodate the Tow Bar - see below. Trolley has aluminum body. Cable/Hose clip not included - order separately from the table below.

Cap. per Trolley (lb)	Part No.	Wt lb (kg)
80	38823	4.75 (2.15)

Cable Trolley

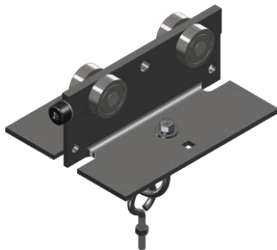

A Cable Trolley is required for each round cable (or hose) loop between the End Clamp and Tow Trolley. Trolley has aluminum body. Cable/Hose clip not included - order separately from the table below.

Cap. per Trolley (lb)	Part No.	Wt lb (kg)
80	38824	3.00 (1.36)

End Clamp



One End Clamp is required at the fixed end of the system. Includes aluminum body, clamp and hardware to secure the cable. Cable/Hose clip not included - order separately from the table below.

Cap. per End Clamp (lb)	Part No.	Wt lb (kg)
80	38825	1.63 (0.74)

Round Cable / Hose Clips

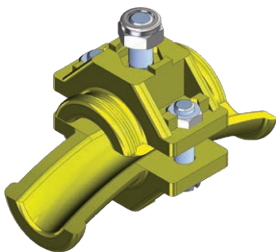

Order the appropriate cable clip for the diameter of the cable or hose. Cable clips can be combined in multiple variations.

For Cable/Hose Diameter in. (mm)	Part No.	Wt lb (kg)
0.39 - 0.63 (10 - 16)	020131-16	0.08 (0.04)
0.67 - 0.98 (17 - 25)	020131-25	0.14 (0.06)
1.02 - 1.42 (26 - 36)	020131-36	0.24 (0.11)

Tow Bar

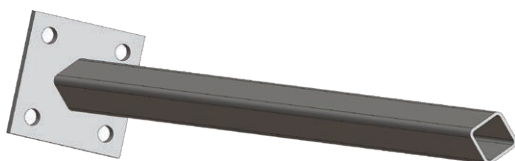

24 in. (610 mm) long. For mounting on moving equipment. One required for each tow trolley. Galvanized finish.

Part No.	Wt lb (kg)
39617C	2.63 (1.19)

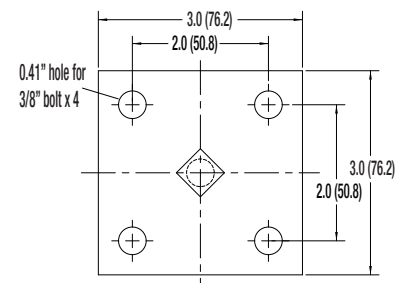

Stretch Wire Rope Festoon Kits - For Flat Cable

Stretch Wire Rope Festoon Kits for flat cable are suited for light duty applications where an intermediate support structure is not available. Economical and dependable, stretch wire rope systems provide electrification to small cranes, moving hoists, and jib cranes. The kits below include standard zinc plated hardware.

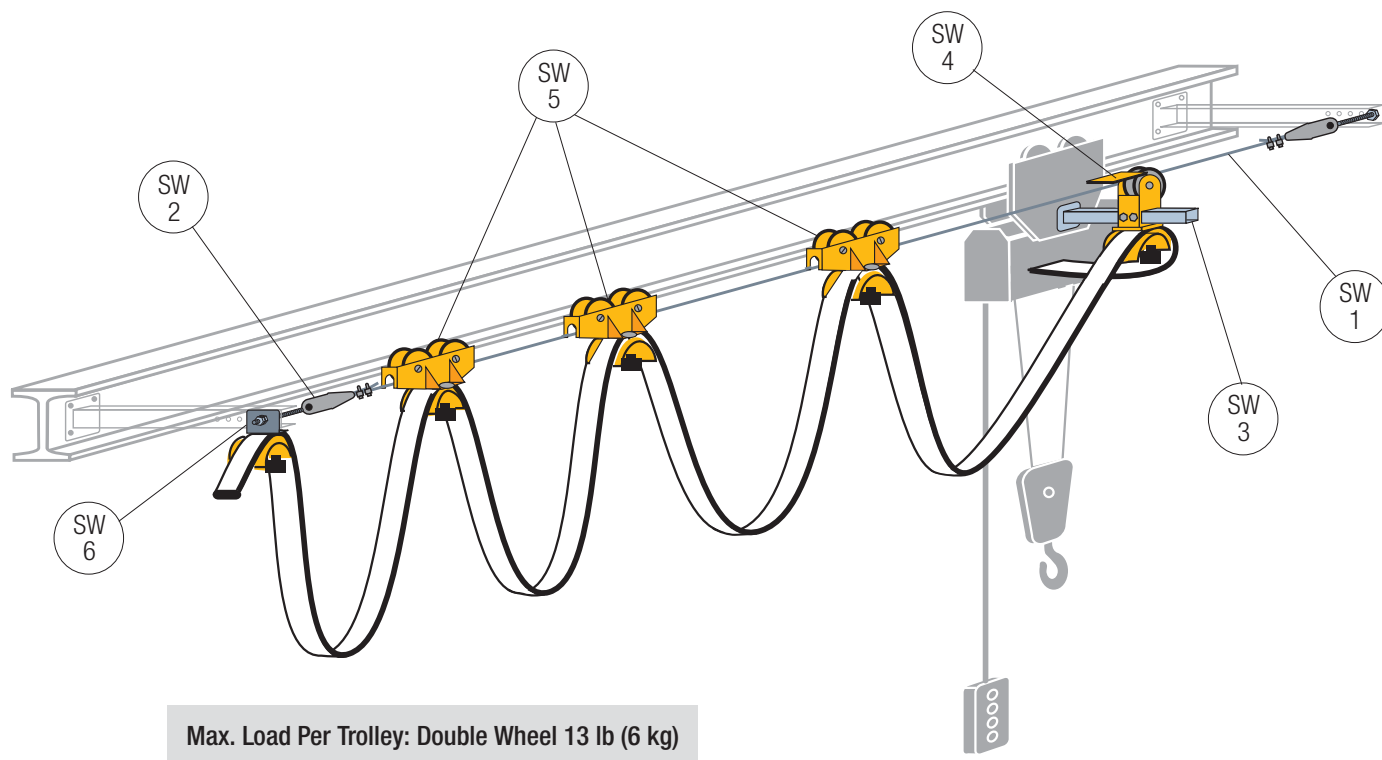

Stretch Wire Rope Festoon Kits Include Parts Listed Below:

Dwg ID	Component	Part No.
SW1	Nylon-coated Wire Rope, 1/4" (6mm) Dia.	22950
SW2	Hardware Kit	23288
SW3	Tow Bar	39617C
SW4	Tow Trolley	021123
SW5	Trolley	021113
SW6	Anchor Bracket	021163

Kits with Double-Wheel Trolleys

Max. Span ft (m)	Kit Part No.	Max Flat Cable Width	Max. Load Per Trolley lb (kg)	No. of Trolleys in Kit
20 (6.1)	24867	1.75 (44.45)	13 (5.90)	3
40 (12.2)	24868			6
60 (18.3)	24869			9
80 (24.4)	24870			13
100 (30.5)	24871			17

Stretch Wire Rope Festoon Kits - For Round Cable or Hose

Stretched Wire Rope Festoon Kits for round cable or hose are suited for light duty applications where an intermediate support structure is not available. Economical and dependable, stretched wire rope systems provide electrification to small cranes, moving hoists, and jib cranes. The kits below include standard zinc plated hardware.

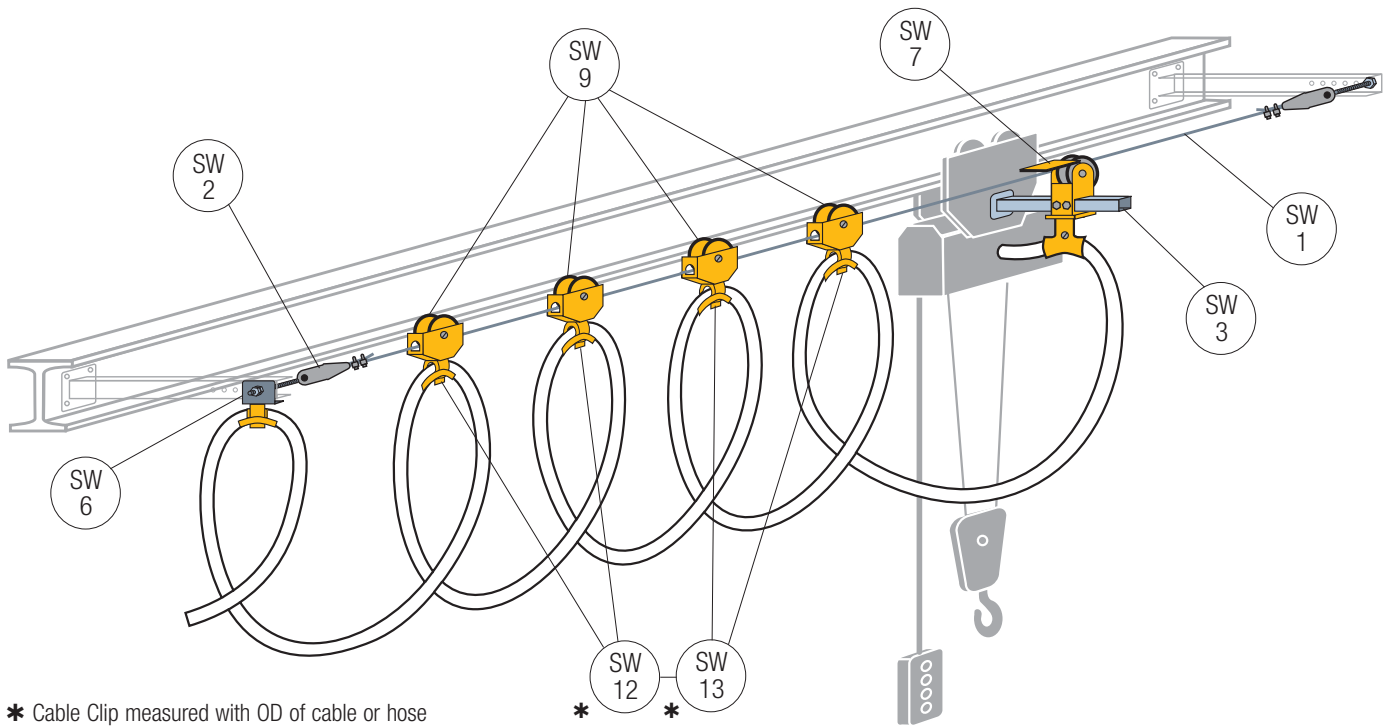

* Cable Clip measured with OD of cable or hose

* *

Max. Load Per Trolley: Double wheel 13 lb (6 kg)

Stretch Wire Festoon Kits Include Parts Listed Below:

Dwg ID	Component	Part No.	Dwg ID	Component	Part No.
SW1	Nylon-coated Wire Rope, 1/4" (6 mm) Dia.	22950	SW9	Trolley	021117
SW2	Hardware Kit	23288	SW12	Cable Clip 3/8" to 9/16" (10 to 15 mm)	020131-16
SW3	Tow Bar	39617C	SW13	Cable Clip 9/16" to 3/4" (15 to 20 mm)	020131-25
SW6	Anchor Bracket	021164			
SW7	Tow Trolley	021124			

Kits with Double-Wheel Trolleys

Max. Span ft (m)	Kit Part No.		No. of Trolleys in Kit
	Dia. Range 3/8" to 9/16" (10-15 mm)	Dia. Range 9/16" to 3/4" (15-20 mm)	
20 (6.1)	24892	24897	3
40 (12.2)	24893	24898	6
60 (18.3)	24894	24899	9
80 (24.4)	24895	24900	13
100 (30.5)	24896	24901	17

Control Trolley Junction Boxes and Terminal Strips

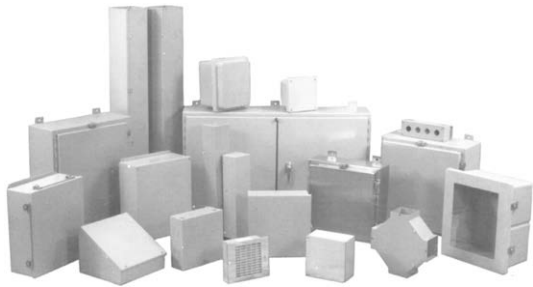

Listed below is an array of standard junction boxes with the listed terminal strip combinations included. These are for use with Control Unit Trolleys - see Pg. 19 and 24. See Pg. 19 for “Quick Disconnect connectors”, which can be used instead of hard-wired junction box.

If you don't see the junction box or terminal arrangement you need, please contact Conductix-Wampfler.

Terminal Strips Included	NEMA*	Size in. (mm)	Material	Part No.	Wt lb (kg)
4 Pole Power (45A)	12	10 x 8 x 4 (254 x 203 x 101)	Painted Steel	52394	10.2 (4.63)
4 Pole Power (45A)	4	10 x 8 x 4 (254 x 203 x 101)	Painted Steel	52394B	10.2 (4.63)
4 Pole Power (45A)	4X	10 x 8 x 4 (254 x 203 x 101)	Stainless Steel	52394C	9.5 (4.31)
4 Pole Power (85A)	12	10 x 8 x 4 (254 x 203 x 101)	Painted Steel	51018	10.3 (4.67)
4 Pole Power (85A)	4	10 x 8 x 4 (254 x 203 x 101)	Painted Steel	51018B	10.3 (4.67)
4 Pole Power (85A)	4X	10 x 8 x 4 (254 x 203 x 101)	Stainless Steel	51018C	9.6 (4.35)
8 Pole Power (85A)	12	10 x 8 x 4 (254 x 203 x 101)	Painted Steel	39415	10.4 (4.72)
8 Pole Power (85A)	4	10 x 8 x 4 (254 x 203 x 101)	Painted Steel	39415B	10.4 (4.72)
8 Pole Power (85A)	4X	10 x 8 x 4 (254 x 203 x 101)	Stainless Steel	39415C	9.7 (4.0)
12 Pole Control (20A)	12	10 x 8 x 4 (254 x 203 x 101)	Painted Steel	28314	10.5 (4.76)
12 Pole Control (20A)	4	10 x 8 x 4 (254 x 203 x 101)	Painted Steel	28314B	10.5 (4.76)
12 Pole Control (20A)	4X	10 x 8 x 4 (254 x 203 x 101)	Stainless Steel	28314N	9.8 (4.45)
24 Pole Control (20A)	12	10 x 8 x 4 (254 x 203 x 101)	Painted Steel	28314C	10.7 (4.85)
24 Pole Control (20A)	4	10 x 8 x 6 (254 x 203 x 152)	Painted Steel	28314D	10.7 (4.85)
24 Pole Control (20A)	4X	10 x 8 x 6 (254 x 203 x 152)	Stainless Steel	28314M	9.8 (4.45)
36 Pole Control (20A)	12	12 x 12 x 6 (305 x 305 x 152)	Painted Steel	36412	14.5 (6.58)
36 Pole Control (20A)	12	14 x 12 x 6 (356 x 305 x 152)	Painted Steel	39109	16.4 (7.44)
36 Pole Control (20A)	4	12 x 12 x 6 (305 x 305 x 152)	Painted Steel	36412B	14.9 (6.76)
36 Pole Control (20A)	4X	12 x 12 x 6 (305 x 305 x 152)	Stainless Steel	36412C	13.5 (6.12)
48 Pole Control (20A)	12	14 x 12 x 6 (356 x 305 x 152)	Painted Steel	35527	16.4 (7.44)
48 Pole Control (20A)	4	14 x 12 x 6 (356 x 305 x 152)	Painted Steel	35527B	16.9 (7.67)
48 Pole Control (20A)	4X	14 x 12 x 6 (356 x 305 x 152)	Stainless Steel	35527C	15.0 (6.80)
12 Pole Control (20A) + 4 Pole Power (85A)	12	10 x 8 x 4 (254 x 203 x 101)	Painted Steel	39362	10.5 (4.76)
12 Pole Control (20A) + 4 Pole Power (85A)	4	10 x 8 x 4 (254 x 203 x 101)	Painted Steel	39362B	10.5 (4.54)
12 Pole Control (20A) + 4 Pole Power (85A)	4X	10 x 8 x 4 (254 x 203 x 101)	Stainless Steel	39362C	10.0 (4.31)
24 Pole Control (20A) + 8 Pole Power (85A)	12	12 x 12 x 6 (305 x 305 x 152)	Painted Steel	39388	14.5 (6.58)
24 Pole Control (20A) + 8 Pole Power (85A)	4	12 x 12 x 6 (305 x 305 x 152)	Painted Steel	39388B	14.9 (6.76)
24 Pole Control (20A) + 8 Pole Power (85A)	4X	12 x 12 x 6 (305 x 305 x 152)	Stainless Steel	39388C	13.5 (6.12)

* For a description of NEMA enclosure ratings, see Pg. 34. As noted above, NEMA 4X boxes are stainless steel. All others are painted steel.

Push Button Pendants

A great complement to your festoon systems is a high quality, ergonomic, and economical **Conductix-Wampfler Push Button Pendant**.

We offer dozens of standard push button pendant configurations to suit the unique needs of demanding industrial users. These modular units are assembled from stocked components for quick delivery and are competitively priced.

The experienced engineering and sales people at Conductix-Wampfler are experts in the application of Push Button Pendants to all kinds of industrial applications.

For details, please request our "Push Button Pendant Catalog" (CAT1001) or download the PDF from www.conductix.us.

Pre-wired Option

All pendants can be ordered pre-wired. Contact Conductix-Wampfler for details.



80 Series

Ergonomic; Accommodates from 2 to 12 buttons. Many configurations. High-impact NEMA 4X case with Neoprene-booted buttons. 2 and 3 button Pistol Grip versions available.

UL / cUL Listed



60 Series

Economical; 2 to 4 buttons. Many configurations available. High-impact NEMA 4 case. A 2-button Pistol Grip version available.

UL / cUL Listed



20 Series

For direct control over small single phase motors at 120 or 240 volts. Durable NEMA 4 housing.

UL / cUL Listed



Appendix I CMAA Crane Classifications & NEMA Ratings

CMAA Crane Classifications

Provided for general information only. Refer to CMAA Section 78-6 for full definitions.

Class A (Standby or Infrequent Service): Performs precise lifts at slow speed, with long idle period between lifts. Performs lifts at full or near rated capacity. Power houses, public utilities, turbine rooms.

Class B (Light Service): Light service requirements at slow speed. Performs 2 to 5 lifts/hour, light to occasional full loads, at 10 feet average height. Repair shops, light assembly, service buildings, light warehousing.

Class C (Moderate Service): Moderate service requirement with loads averaging 50% of capacity. 5 to 10 lifts per hour at 15 feet average lift height. Not more than 50% of lifts at rated capacity. Machine shops, paper mill machine rooms, etc.

Class D (Heavy Service): Bucket/magnet duty, where heavy duty production is required. Loads of 50% capacity handled constantly. 10 to 20 lifts per hour averaging 15 feet lift height. Not over 65% of the lifts at rated capacity. Heavy machine shops, foundries, fabricating plants, steel warehouses, container yards, lumber mills, etc.

Class E (Severe Service): Loads approaching capacity throughout the life of the crane. 20 or more lifts per hour at or near rated capacity. Magnet/bucket cranes for scrap yards, cement mills, lumber mills, fertilizer plants, container handling.

Class F (Continuous Severe Service): Handles loads approaching capacity continuously under severe service conditions throughout the life of the crane. Includes custom designed specialty cranes performing work critical to the total production facility. Needs to have the highest reliability and ease of maintenance.

NEMA Enclosure Ratings

Provided for general information only. Refer to NEMA Standard 250 and IP AS 1939-1986 for full definitions.

Note: All enclosure types provide a degree of protection to personnel against incidental contact with the enclosed equipment.

NEMA 1 (IP10): Enclosures constructed for indoor use to provide a degree of protection against falling dirt

NEMA 2 (IP11): Enclosures constructed for indoor use to provide a degree of protection against falling dirt, and to provide a degree of protection against dripping and light splashing of liquids

NEMA 3 (IP54): Enclosures constructed for either indoor or outdoor use to provide a degree of protection against falling dirt, rain, sleet, snow, and windblown dust; and that will be undamaged by external formation of ice on the enclosure

NEMA 3R (IP14): Enclosures constructed for either indoor or outdoor use to provide a degree of protection against falling dirt, rain, sleet, and snow; and that will be undamaged by external formation of ice on the enclosure. (Enclosure can be vented.)

NEMA 4 (IP56): Enclosures constructed for either indoor or outdoor use to provide a degree of protection against falling dirt, rain, sleet, snow, windblown dust, splashing water, and hose-directed water, and that will be undamaged by the external formation of ice on the enclosure

NEMA 4X (IP56): Enclosures constructed for either indoor or outdoor use to provide a degree of protection against falling dirt, rain, sleet, snow, windblown dust, splashing water, hose-directed water, and corrosion and that will be undamaged by the external formation of ice on the enclosure

NEMA 6 (IP67): Enclosures constructed for either indoor or outdoor use to provide a degree of protection against damage by the external formation of ice on the enclosure.

NEMA 12 (IP52): Enclosures constructed (without knockouts) for indoor use to provide a degree of protection against falling dirt; against circulating dust, lint, fibers, and flying debris and against dripping and light splashing of liquids.

NEMA 13 (IP54): Enclosures constructed for indoor use to provide a degree of protection against falling dirt, circulating dust, lint, fibers, and flying debris and against the spraying, splashing, and seepage of water, oil, and non-corrosive coolants.

For information on hazardous location specifications, please contact Conductix-Wampfler.

Appendix II Motor Amperage and Electrical Formulas

The chart below lists the most common combinations of motor HP (horsepower) in relation to voltage used and the resulting amperage draw. To use the chart, determine amperage draw based on horsepower and voltage. Then use the Cable Data Chart in Appendix III to determine cable gauge and number of conductors required for your application. Direct Current requires two conductors. Single phase requires three conductors. Three-phase requires four conductors.

MOTOR AMPERAGE DRAW (AT FULL LOAD OF 60 Hz)															
3 PHASE AC Induction Type - Squirrel Cage & Wound Rotor								Single Phase			Direct Current				
HP	115V	200V	230V	460V	575V	2300V	4160V	HP	115V	230V	HP	120V	240V	HP	240V
1/2	4.0	2.3	2.0	1.0	.8			1/6	4.4	2.2					
3/4	5.6	3.2	2.8	1.4	1.1			1/4	5.8	2.9	1/4	2.9	1.5	15	55
1	7.2	4.15	3.6	1.8	1.4			1/3	7.2	3.6	1/3	3.6	1.8	20	72
1 1/2	10.4	6.0	5.2	2.6	2.1			1/2	9.8	4.9	1/2	5.2	2.6	25	89
2	13.6	7.8	6.8	3.4	2.7			3/4	13.8	6.9	3/4	7.4	3.7	30	106
3		11.0	9.6	4.8	3.9			1	16.0	8.0	1	9.4	4.7	40	140
5		17.5	15.2	7.6	6.1			1 1/2	20.0	10.0	1 1/2	13.2	6.6	50	173
7 1/2	25.0	22.0	11.0	9.0				2	24.0	12.0	2	17.0	8.5	60	206
10		32.0	28.0	14.0	11.0			3	34.0	17.0	3	25.0	12.5	75	225
15		48.0	42.0	21.0	17.0			5	56.0	28.0	5	40.0	20.0	100	341
20		62.0	54.0	27.0	22.0			7 1/2	80.0	40.0	7 1/2	58.0	29.0	125	425
25		78.0	68.0	34.0	27.0			10	100.0	50.0	10	76.0	38.0	150	506
30		92.0	80.0	40.0	32.0										
40		120.0	104.0	52.0	41.0										
50		150.0	130.0	65.0	52.0										
60		177.0	154.0	77.0	62.0	16.0	8.9								
75		221.0	192.0	96.0	77.0	20.0	11.0								
100		285.0	248.0	124.0	99.0	26.0	14.4								
125		358.0	312.0	156.0	125.0	31.0	17.0								
150		415.0	360.0	180.0	144.0	37.0	20.5								
200		550.0	480.0	240.0	192.0	49.0	27.0								

Ohms Law

$$\text{Ohms} = \frac{\text{Volts}}{\text{Amperes}} \quad \text{Amperes} = \frac{\text{Volts}}{\text{Ohms}}$$

$$\text{Volts} = \text{Amperes} \times \text{Ohms}$$

Speed Formulas

$$\text{Synchronous RPM} = \frac{F \times 120}{\# \text{ of poles}}$$

$$\text{Percent Slip} = \frac{\text{Synchronous RPM} - \text{Full Load RPM}}{\text{Synchronous RPM}} \times 100$$

Power Formulas

$$\text{Watts} = \text{Amperes} \times \text{Volts}$$

$$\text{Amperes} = \frac{\text{Watts}}{\text{Volts}}$$

$$\text{HP} = \frac{\text{Volts} \times \text{Amperes} \times \text{Efficiency}}{746}$$

$$\text{Power Factor} = \frac{\text{Watts}}{\text{Amperes} \times \text{Volts}}$$

$$\text{Single-Phase Kilowatts} = \frac{\text{Volts} \times \text{Amperes} \times \text{Power Factor}}{1000}$$

$$\text{Single-phase Amperes} = \frac{746 \times \text{HP (Horsepower)}}{\text{Volts} \times \text{Efficiency} \times \text{Power Factor}}$$

$$\text{Three Phase Kilowatts} = \frac{\text{Volts} \times \text{Amperes} \times \text{Power Factor} \times 1.732}{1000}$$

$$\text{Three Phase Amperes} = \frac{746 \times \text{HP (Horsepower)}}{1.732 \times \text{Volts} \times \text{Efficiency} \times \text{Power Factor}}$$

$$\text{Volts-Amperes} = \text{Volts} \times \text{Amperes}$$

Appendix III Round Cable Data (AWG)

The data on this page is for **general information only** applicable to cable sold by Conductix-Wampfler for use with round cable festoon systems. Nominal diameters and weights shown will vary with different manufacturers.

If you don't see the cable types and sizes you need - please Contact Conductix-Wampfler.

Type SOW-A or SOOW-A (90° C Insulation)					
AWG	# of Con.	Amps	Dia. in. (mm)	Wt lb/ft (kg/m)	Part No.
16	2	10	0.41 (10.24)	0.08 (0.04)	33017
16	3	10	0.43 (10.92)	0.09 (0.04)	33018
16	4	8	0.49 (12.32)	0.12 (0.05)	33019
16	6	8	0.57 (14.35)	0.18 (0.08)	33020
16	7	7	0.61 (15.37)	0.20 (0.09)	35158
16	8	7	0.65 (16.38)	0.22 (0.10)	33021
16	10	5	0.72 (18.29)	0.28 (0.13)	33022
16	12	5	0.74 (18.80)	0.31 (0.14)	33023
16	14	5	0.78 (19.69)	0.35 (0.16)	33024
16	16	5	0.83 (20.96)	0.39 (0.18)	33025
16	20	5	0.90 (22.86)	0.47 (0.21)	33026
16	24	5	1.02 (25.78)	0.57 (0.26)	33027
14	2	15	0.53 (13.46)	0.14 (0.06)	33029
14	3	15	0.56 (14.22)	0.17 (0.08)	33030
14	4	12	0.61 (15.37)	0.21 (0.10)	33031
14	6	12	0.74 (18.80)	0.31 (0.14)	33032
14	8	10.5	0.85 (21.46)	0.36 (0.16)	33033
14	10	7.5	0.91 (22.99)	0.43 (0.20)	33034
14	12	7.5	0.93 (23.62)	0.35 (0.16)	33035
14	14	7.5	0.98 (24.89)	0.56 (0.25)	33036
14	16	7.5	1.08 (27.31)	0.66 (0.30)	33037
14	20	7.5	1.18 (29.97)	0.79 (0.36)	33038
14	24	7.5	1.29 (32.77)	0.92 (0.42)	33039
12	2	20	0.61 (15.34)	0.17 (0.08)	33041
12	3	20	0.64 (16.26)	0.23 (0.10)	33042
12	4	16	0.67 (17.02)	0.28 (0.13)	33043
12	6	16	0.80 (20.32)	0.37 (0.17)	33044
12	8	14	0.92 (23.24)	0.45 (0.20)	33045
12	10	10	1.02 (25.78)	0.56 (0.25)	33046
12	12	10	1.05 (26.54)	0.64 (0.29)	33047
12	16	10	1.16 (29.34)	0.84 (0.38)	33048
12	20	10	1.29 (32.64)	1.00 (0.45)	33049
10	2	25	0.64 (16.26)	0.22 (0.10)	33052
10	3	25	0.69 (17.53)	0.28 (0.13)	33053
10	4	20	0.75 (19.05)	0.38 (0.17)	33054
10	6	20	0.88 (22.35)	0.48 (0.22)	33645
10	7	17.5	0.98 (24.89)	0.59 (0.27)	35667
10	8	17.5	1.05 (26.67)	0.65 (0.29)	33055
10	10	12.5	1.13 (28.58)	0.76 (0.34)	33056
10	12	12.5	1.16 (29.34)	0.85 (0.39)	33057

Type W (90° C Insulation)					
AWG	# of Con.	Amps	Dia. in. (mm)	Wt lb/ft (kg/m)	Part No.
8	2	50	0.81 (20.57)	0.42 (0.19)	33058
8	3	50	0.91 (23.11)	0.60 (0.27)	33059
8	4	45	0.99 (25.15)	0.68 (0.31)	33060
6	2	65	0.93 (23.62)	0.57 (0.26)	33061
6	3	65	1.01 (25.65)	0.75 (0.34)	33062
6	4	55	1.10 (27.94)	0.88 (0.40)	33063
4	2	75	1.08 (27.43)	0.79 (0.36)	33064
4	3	75	1.17 (29.72)	0.98 (0.44)	33065
4	4	65	1.27 (32.26)	1.22 (0.55)	33066
2	2	110	1.27 (32.26)	1.14 (0.52)	33067
2	3	110	1.34 (34.04)	1.41 (0.64)	33068

* Amp ratings are based on an ambient temperature of 30°C, derated for cables with more than 3 current carrying conductors per NEC. Ampacity requirements are solely dependent on applicable local codes. Conductix-Wampfler cannot specifically recommend required ampacity.

Appendix IV Metric Conversion Tables

AWG / Metric Conductor Size Conversion			
AWG or MCM	Circular Mils	Cross-Sectional Area (mm ²)	Metric Conductor Size
	987	.50	.50
20 AWG	1020	.52	
	1480	.75	.75
18	1620	.82	
	1970	1.0	1.0
16	2580	1.31	
	2960	1.50	1.5
14	4110	2.08	
	4930	2.50	2.5
12	6530	3.31	
	7890	4.00	4.0
10	10380	5.26	
	11800	6.00	6.0
8	16510	8.37	
	19700	10.00	10.0
6	26240	13.30	
	31600	16.00	16.0
4	41740	21.15	
	49300	25.00	25.0
2	66360	33.63	
	69100	35.00	35.0
1	83690	42.41	
	98700	50.00	50.0
1/0	105600	53.48	
2/0	133100	67.43	
	138000	70.00	70.0
3/0	167800	85.03	
	187000	95.00	95.0
4/0	211600	107.20	
	237000	120.00	120.0
250 MCM	250000	126.64	
	296000	150.00	150.0
300	300000	152.00	
350	350000	177.35	
	365000	185.00	185.0
400	400000	202.71	
	474000	240.00	240.0
500	500000	253.35	
	592000	300.00	300.0
600	600000	303.96	
750	750000	379.95	
	789000	400.00	400.0
	987000	500.00	500.0
1000	1000000	506.60	

Celsius / Fahrenheit Temperature Conversion								
1. Locate known temperature in °C/°F column.								
2. Read converted temperature in either the °C or °F column.								
°C	°C / F	°F	°C	°C / F	°F	°C	°C / F	°F
-45.4	-50	-58	15.5	60	140	76.5	170	338
-42.7	-45	-49	18.3	65	149	79.3	175	347
-40.0	-40	-40	21.1	70	158	82.1	180	356
-37.2	-35	-31	23.9	75	167	85.0	185	365
-34.4	-30	-22	26.6	80	176	87.6	190	374
-32.2	-25	-13	29.4	85	185	90.4	195	383
-29.4	-20	-4	32.2	90	194	93.2	200	392
-26.6	-15	5	35.0	95	203	96.0	205	401
-23.8	-10	14	37.8	100	212	98.8	210	410
-20.5	-5	23	40.5	105	221	101.6	215	419
-17.8	0	32	43.4	110	230	104.4	220	428
-15.0	5	41	46.1	115	239	107.2	225	437
-12.2	10	50	48.9	120	248	110.0	230	446
-9.4	15	59	51.6	125	257	112.8	235	455
-6.7	20	68	54.4	130	266	115.6	240	464
-3.9	25	77	57.1	135	275	118.2	245	473
-1.1	30	86	60.0	140	284	120.9	250	482
1.7	36	95	62.7	145	293	123.7	255	491
4.4	40	104	65.5	150	302	126.5	260	500
7.2	45	113	68.3	155	311	129.3	265	509
10.0	50	122	71.0	160	320	132.2	270	518
12.8	55	131	73.8	165	329	135.0	275	527

Temperature Conversion Formula
 $^{\circ}\text{F} = (9/5 \times ^{\circ}\text{C}) + 32$ $^{\circ}\text{C} = 5/9 (^{\circ}\text{F} - 32)$

To Obtain	Multiply
Millimeters	Inches x 25.4
Inches	Millimeters x 0.0394
Meters	Feet x .3048
Feet	Meters x 3.281
Square Centimeters	Square Inches x 6.45
Square Inches	Square Centimeters x 0.155
Kilograms	Pounds x 0.4536
Pounds	Kilograms x 2.205
Pounds per Foot	Newtons per Meter x 1.356
Newtons per Meter	Lbs per ft x 0.738
Kilowatts	Horse Power x 1.341
Horse Power	Kilowatts x 0.746

Appendix V Terms, Conditions, and Warranty

The technical data and images which appear in this catalog are for informational purposes only. NO WARRANTIES, EXPRESSED OR IMPLIED, INCLUDING WARRANTIES OF MERCHANTABILITY OR FITNESS FOR A PARTICULAR PURPOSE, ARE CREATED BY THE DESCRIPTIONS AND DEPICTIONS OF THE PRODUCTS SHOWN IN THIS CATALOG. Conductix-Wampfler (“seller”) makes no warranty and assumes no liability as to the function of equipment or the operation of systems built according to customer design or of the ability of any of its products to interface, operate or function with any portions of customer systems not provided by Conductix-Wampfler.

Seller agrees to repair or exchange the goods sold hereunder necessitated by reason of defective workmanship, and material discovered and reported to Seller within one year after shipment of such goods to Buyer. Except where the nature of the defect is such that it is appropriate in Seller’s judgement to effect repairs on site, the seller’s obligation hereunder to remedy defects shall be limited to repairing or replacing (at Seller’s option), FOB point of original shipment by Seller, any part returned to Seller at the risk and cost of Buyer. Defective parts replaced by Seller shall become the property of Seller.

Seller shall only be obligated to make such repair or replacement of the goods which have been used by Buyer in service recommended by Seller and altered only as authorized by Seller. Seller is not responsible for defects which arise from improper installation, neglect, or improper use or from normal wear and tear.

Additionally, Seller’s obligation shall be limited by the manufacturer’s warranty (and shall not be further warranted by Seller) for all parts procured from others according to published data, specifications, or performance information not designed by or for Seller.

Seller further agrees to replace, or at Seller’s option to provide a refund of the sales price of any goods that did not conform to applicable specifications or which differ from that agreed to be supplied which non-conformity is discovered and forthwith reported to Seller within thirty (30) days after shipment to Buyer. Seller’s obligation to replace or refund the purchase price for non-conforming goods shall arise once Buyer returns such good FOB point of original shipment by Seller at the risk and cost of Buyer. Goods replaced by Seller shall be come property of Seller.

There is no guarantee or warranty as to anything made or sold by Seller, or any service performed, except as to title and freedom from encumbrances, and except as herein expressly stated and particularly without limiting the foregoing. There is no guarantee or warranty, express or implied, of merchantability or of fitness for any particular purpose or against claim of infringement or the like.

Seller makes no warranty (and assumes no liability) as to function of equipment or operation of systems built to Buyer’s design or of the ability of any goods to interface, operate or function with any portions of Buyer’s system not provided by Seller.

Seller’s liability on any claim; whether in contract (including negligence) or otherwise, for any loss or damage arising out of, connected with, or resulting from the manufacture, sale, delivery, resale, repair, replacement or use of any products or, services shall in no case exceed the price paid for the product or services or any part thereof which give rise to the claim. In no event shall Seller be liable for consequential, special, incidental or other damages, nor shall Seller be liable in respect to personal injury or damage to property on the subject matter hereof unless attributable to gross misconduct of Seller, which shall mean an act of omission by Seller demonstrating reckless disregard of the foreseeable consequences thereof.

Seller is not responsible for incorrect choice of models or where products are used in excess of their rated and recommended capacities and design functions or under abnormal conditions. Seller assumes no liability for loss of time, damage or injuries to property or persons resulting from the use of Seller’s products. Buyer shall hold Seller harmless from all liability, claims, suits and expenses in connection with loss or damage resulting from operation of products or utilization of services, respectively, of Seller and shall defend any suit or action which might arise there from Buyer’s name, provided that Seller shall have the right to elect to defend any such suit or action for the account of Buyer. The foregoing shall be the exclusive remedies of the buyer and all persons and entitles claiming through the Buyer.



Other Products from Conductix-Wampfler

The products described in this catalog represent a few of the products from the broad spectrum of Conductix-Wampfler components and systems for the transfer of energy, data, gases, and fluids. The solutions we deliver for your applications are based on your specific requirements. In many cases, a combination of several different Conductix-Wampfler products are needed to fill the application. You can count on all of Conductix-Wampfler's business units for hands-on engineering support - coupled with the perfect solution to meet your energy management and control needs.



Motor driven cable reels

Motor driven reels by Conductix-Wampfler are the perfect solution for managing long lengths of heavy cable and hoses in very demanding industrial applications. Monospiral, level wind, and random wind spools.



Slip ring assemblies

Whenever powered machinery needs to rotate 360°, field proven slip ring assemblies by Conductix-Wampfler can flawlessly transfer energy and data. Here, everything revolves around flexibility and reliability.



Conductor bar

Whether they are enclosed conductor rails, expandable single-pole bar systems, or high amperage bar for demanding steel mill use up to 6000 amps. Conductix-Wampfler's conductor bar is the proven solution to reliably move people and material.



Spring driven cable reels

We have 60 years experience and trusted brands such as Insul-8, Wampfler, and IER. We offer small cord reels all the way to large multi-motor units, a wide range of accessories, and hazardous location reels.



Cable Festoon systems

It's hard to imagine Conductix-Wampfler cable trolleys not being used in virtually every industrial application. They are reliable and robust and available in an enormous variety of sizes and models.



Push Button Pendants

Our ergonomic pendants are ideally suited for industrial control applications. They are available in a wide range of configurations for overhead cranes and other machinery.



Radio remote controls

Safe, secure, and reliable radios use the latest in microprocessor technology. Available in several models for overhead crane control and other types of machinery.



Inductive Power Transfer IPT®

The contact-less system for transferring energy and data. For all tasks that depend on high speeds and absolute resistance to wear.



Energy guiding chains

The "Jack of all Trades" when it comes to managing energy and data cables and air and fluid hoses. A wide range of energy guiding chains are available for many industrial applications.



Air hoists and balancers

ENDO Air hoists accurately place delicate loads and continuously vary the speed for precise positioning. They run cool in continuous operations.



Bumpers

Conductix-Wampfler offers a complete range of bumpers for the auto industry, cranes, and heavy machinery. These include rubber, rubber/metal, and cellular types.



Spring balancers and retractors

ENDO spring balancers by Conductix-Wampfler are rugged, reliable high-precision positioning devices that reduce operator fatigue and assist with accurate tool placement.

www.conductix.us

Conductix-Wampfler

has just one critical mission:
To provide you with energy and
data transmission systems that
will keep your operations up
and running 24/7/365.

To contact your nearest
sales office, please refer to:

www.conductix.contact

