

Radio Remote Control Manual

Copy Module Series K, L and Protean

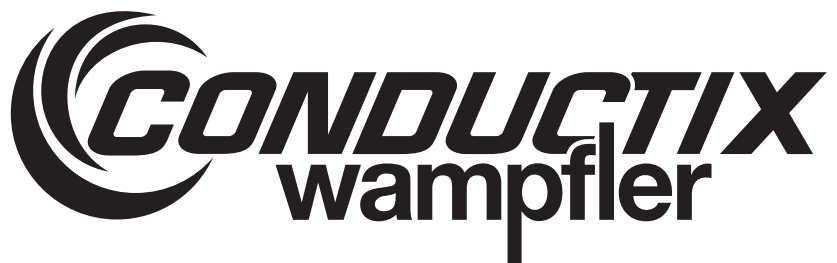
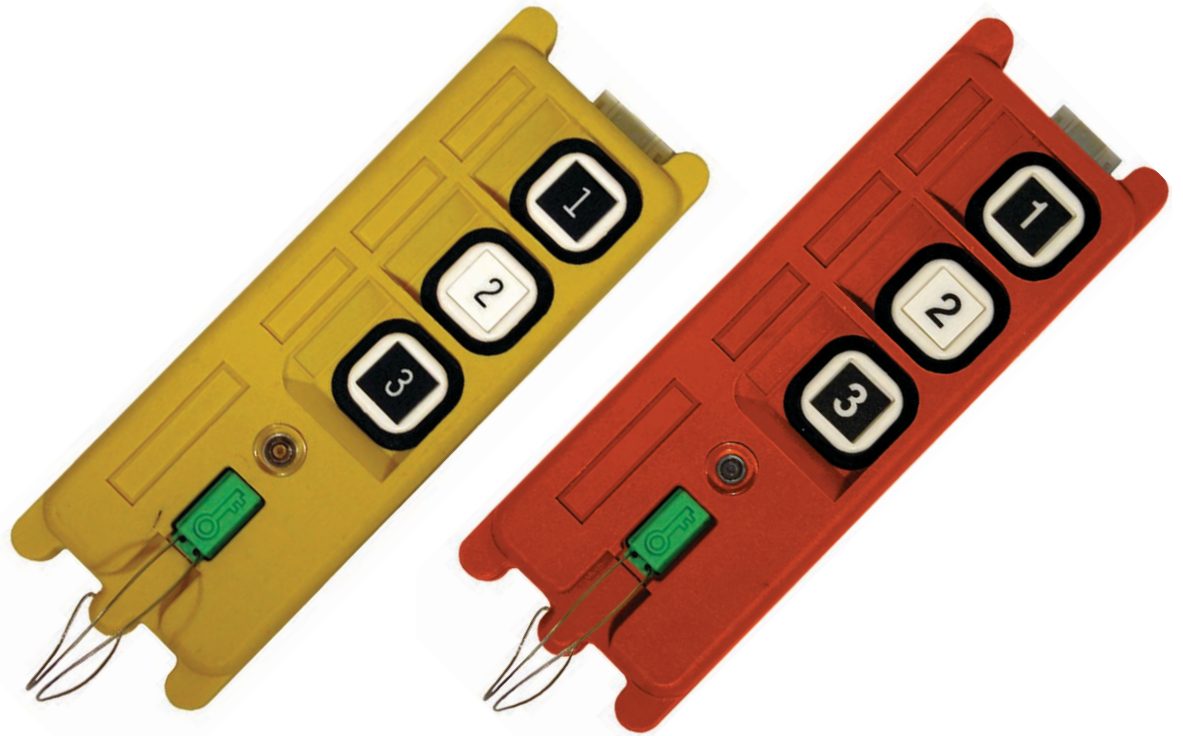

Conductix Incorporated

The technical data and images which appear in this manual are for informational purposes only. **NO WARRANTIES, EXPRESS OR IMPLIED, INCLUDING WARRANTIES OF MERCHANTABILITY OR FITNESS FOR A PARTICULAR PURPOSE, ARE CREATED BY THE DESCRIPTIONS AND DEPICTIONS OF THE PRODUCTS SHOWN IN THIS MANUAL.** Conductix makes no warranty (and assumes no liability) as to function of equipment or operation of systems built according to customer design or of the ability of any of its products to interface, operate or function with any portions of customer systems not provided by Conductix.

Seller agrees to repair or exchange the goods sold hereunder necessitated by reason of defective workmanship and material discovered and reported to Seller within one year after shipment of such goods to Buyer.

Except where the nature of the defect is such that it is appropriate, in Seller's judgment, to effect repairs on site, Seller's obligation hereunder to remedy defects shall be limited to repairing or replacing (at Seller's option) FOB point of original shipment by Seller, any part returned to Seller at the risk and cost of Buyer. Defective parts replaced by Seller shall become the property of Seller.

Seller shall only be obligated to make such repair or replacement if the goods have been used by Buyer only in service recommended by Seller and altered only as authorized by Seller. Seller is not responsible for defects which arise from improper installation, neglect, or improper use or from normal wear and tear.

Additionally, Seller's obligation shall be limited by the manufacturer's warranty (and is not further warranted by Seller) for all parts procured from others according to published data, specifications or performance information not designed by or for Seller.

Seller further agrees to replace or at Seller's option to provide a refund of the sales price of any goods that do not conform to applicable specifications or which differ from that agreed to be supplied which non-conformity is discovered and forthwith reported to Seller within thirty (30) days after shipment to the Buyer. Seller's obligation to replace or refund the purchase price for non-conforming goods shall arise once Buyer returns such goods FOB point of original shipment by Seller at the risk and cost of Buyer. Goods replaced by Seller shall become the property of Seller.

There is no guarantee or warranty as to anything made or sold by Seller, or any services performed, except as to title and freedom from encumbrances and, except as herein expressly stated and particularly, and without limiting the foregoing, **there is no guarantee or warranty, express or implied, of merchantability or of fitness for any particular purpose or against claim of infringement or the like.**

Seller makes no warranty (and assumes no liability) as to function of equipment or operation of systems built to Buyer's design or of the ability of any goods to interface, operate or function with any portions of Buyer's system not provided by Seller.

Seller's liability on any claim, whether in contract, tort (including negligence), or otherwise, for any loss or damage arising out of, connected with, or resulting from the manufacture, sale, delivery, resale, repair, replacement or use of any products or services shall in no case exceed the price paid for the product or services or any part thereof which give rise to the claim. In no event shall Seller be liable for consequential, special, incidental or other damages, nor shall Seller be liable in respect of personal injury or damage to property not the subject matter hereof unless attributable to gross misconduct of Seller, which shall mean an act or omission by Seller demonstrating reckless disregard of the foreseeable consequences thereof.

Seller is not responsible for incorrect choice of models or where products are used in excess of their rated and recommended capacities and design functions or under abnormal conditions. Seller assumes no liability for loss of time, damage or injuries to property or persons resulting from the use of Seller's products. Buyer shall hold Seller harmless from all liability, claims, suits and expenses in connection with loss or damage resulting from operation of products or utilization of services, respectively, of Seller and shall defend any suit or action which might arise there from in Buyer's name - provided that Seller shall have the right to elect to defend any such suit or action for the account of Buyer. The foregoing shall be the exclusive remedies of the Buyer and all persons and entities claiming through the Buyer.

1.0 Instructions

- 1.1 Application
- 1.2 Functions Memorized
- 1.3 Controls
- 1.4 Precautions
- 1.5 Battery Installation

2.0 K1 / K2 Series Operation

3.0 K3 / K4 Series Operation

4.0 L10 Series Operation

5.0 L12 Series Operation

6.0 L40 Series Operation

7.0 Protean Series Operation

1.0 Instructions

1.1 Application

After replacing or repairing PC boards in the radio remote control, use the Copier to memorize the existing functions from the old Transmitter (TX) or Receiver (RX). Then download to the new TX or RX fast and efficiently. The Copier can upload/download (respectively) three (3) sets of required functions from/to the TX or RX by buttons 1, 2 or 3.

NOTE: When using with the the L40 series radio, only one program can be stored in the copier as the program will consume all the memory regardless of which button is pressed

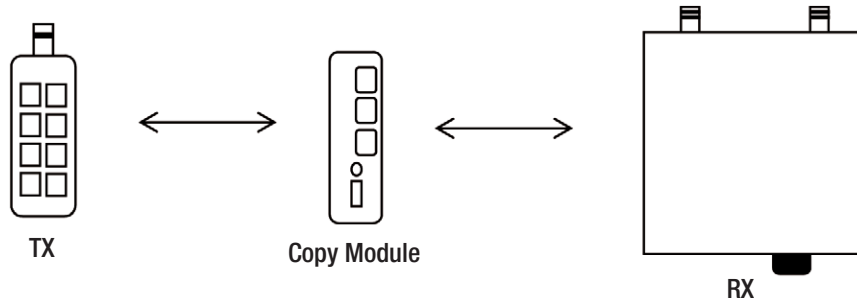

1.2 Functions Memorized:

The functions that are uploaded/memorized to/from the TX or RX by the Copier include all of function settings, except TX Serial Number, RX Serial Number, TX Date and RX Date.

1.3 Controls

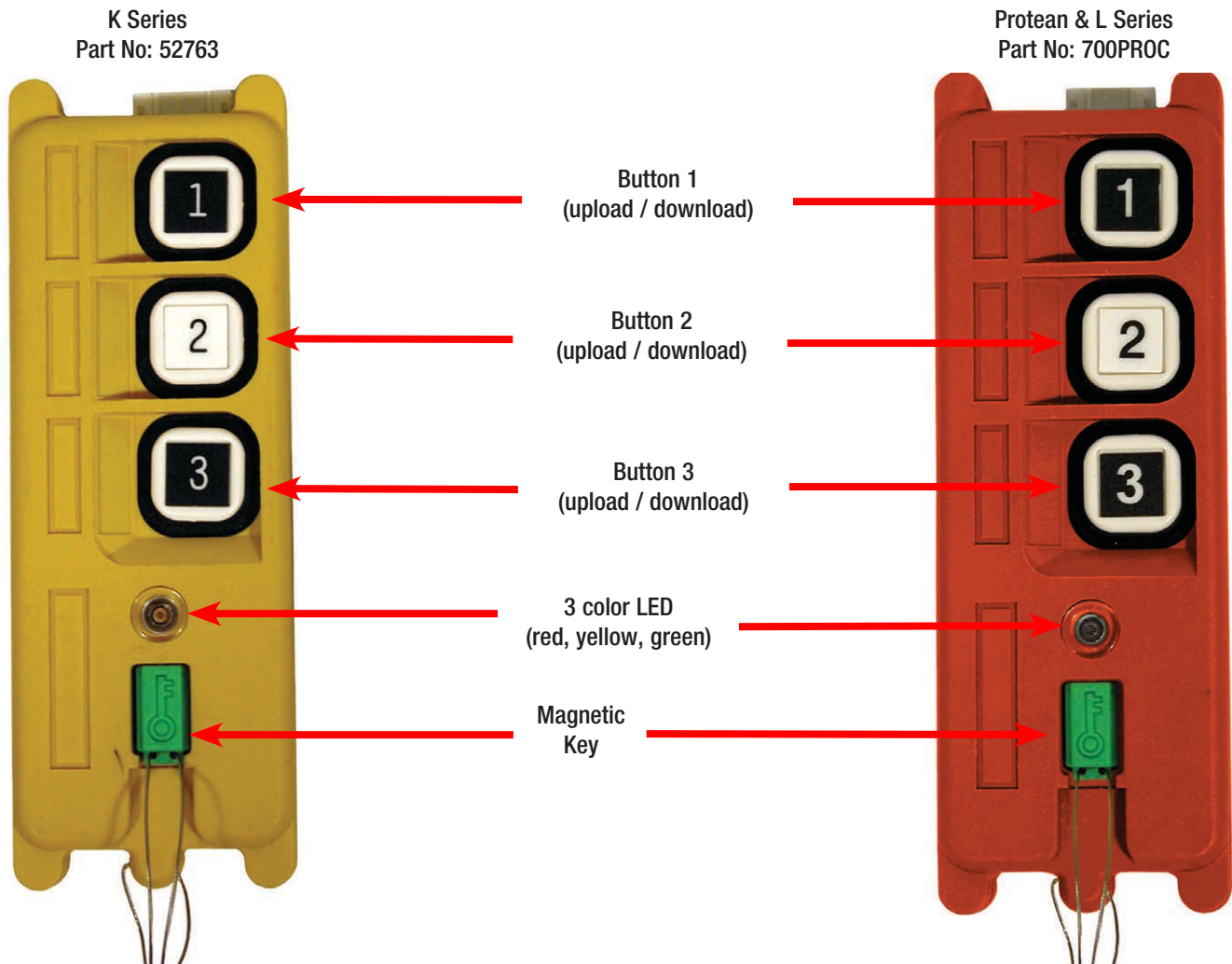

1.0 Instructions

1.4 Precautions

1. Copier will not successfully upload/download if the memorized functions are from a different model of radio remote control.
2. When using the Copier for copying/memorizing to/from the RX, one must turn off the RX power supply; otherwise it will damage the RX's memory IC (EEPROM).
3. Functions must be memorized in the Copier when uploading; otherwise neither the TX nor the RX will work.
4. It is normal if the Copier's LED illuminates red when pressing buttons on the Copier to test without being connected to a TX or RX.
5. When not in use, please remove the magnetic key from the Copier to save power.
6. If the Copier's battery power is insufficient, the Copier's LED will illuminate red, yellow, and green sequentially.
7. It is abnormal if the Copier's LED illuminates red when copying, please contact Insul 8 for assistance.

1.5 Battery Installation

1. Unscrew the four (4) screws on the bottom cover of the Copier with a Phillips head screwdriver.
2. Open the bottom cover of the Copier and place two (2) AA-size 1.5V alkaline batteries paying attention to their polarity.
3. Put the bottom cover on the Copier and tighten the four (4) screws.
4. Remove batteries if copier is not to be used for over one (1) week's time to avoid potential damage due to leaking batteries.

NOTE: Copier retains memory without batteries installed.

2.0 K1 / K2 Operation

2.1 Procedure for copying / saving program from the TX to the copier

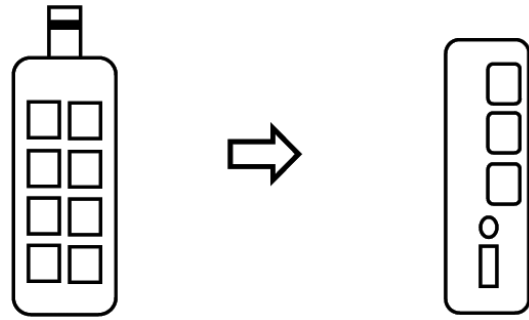
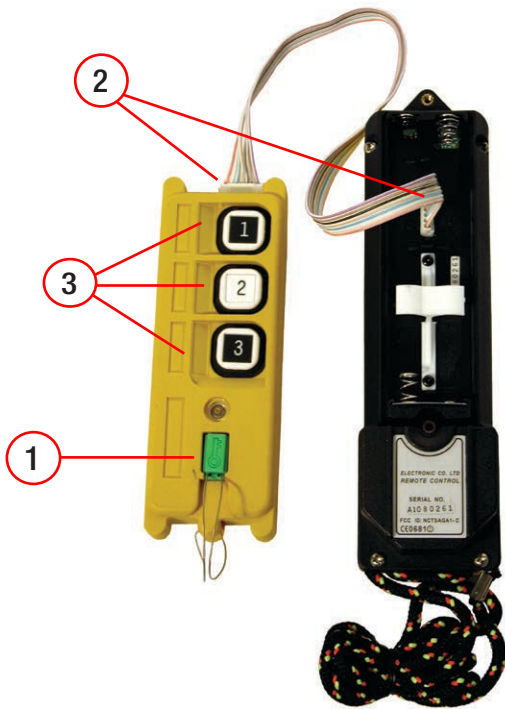

- 2.1.1 Place the Magnetic Key into the Copier (ON).
- 2.1.2 Connect the interface cable from the Copier to the TX.
- 2.1.3 Press and hold one of the Copier's buttons you wish to use for about 5 seconds until the Copier's LED illuminates green (it is abnormal if the Copier's LED illuminates red).
- 2.1.4 Unplug the interface cable.

2.2 Procedure for copying / saving program from the RX to the copier

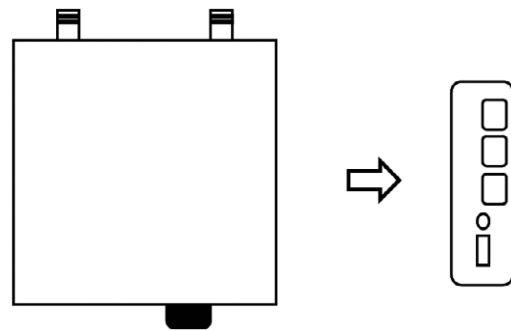
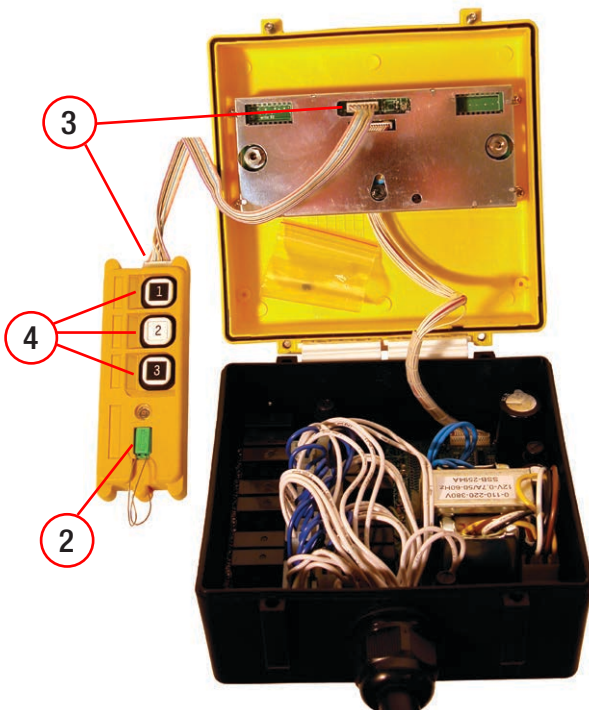

- 2.2.1 Turn off the RX power supply. The RX power supply must be turned off otherwise it will damage the RX's memory IC (EEPROM).
- 2.2.2 Place the Magnetic Key into the Copier (ON).
- 2.2.3 Connect the interface cable from the Copier to the RX.
- 2.2.4 Press and hold one of the Copier's buttons you wish to use, until the Copier's LED illuminates green (it is abnormal if the Copier's LED illuminates red).
- 2.2.5 Unplug the interface cable.

REMARK: After the memorizing is completed, one should remember/ record which button was used to memorize the required functions (in order to press the same button to upload the required functions to the same model of radio remote control).

2.0 K1 / K2 Operation

2.3 Procedure for overwriting / replacing program to TX using the copier

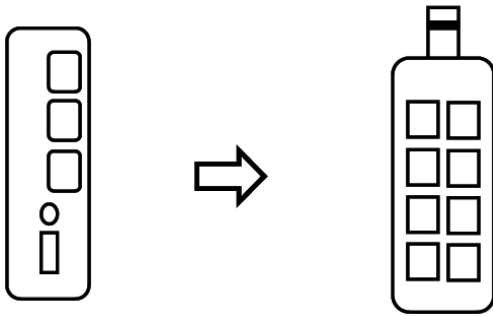

- 2.3.1 Take the Magnetic Key out of the Copier (OFF).
- 2.3.2 Connect the interface cable from the Copier to the TX.
- 2.3.3 Press and hold the Copier's button that was used to memorize the required functions until the Copier's LED illuminates green (it is abnormal if the Copier's LED illuminates red).
- 2.3.4 Unplug the interface cable.
- 2.3.5 Programming of the transmitter is now complete.

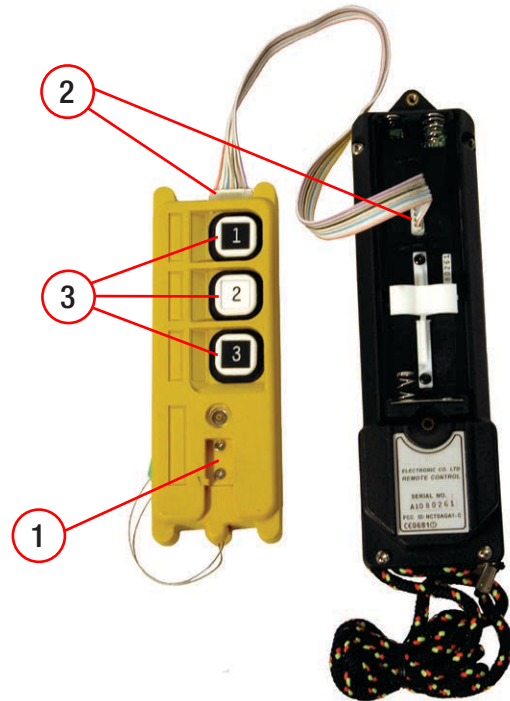

2.4 Procedure for overwriting / replacing program to RX using the copier

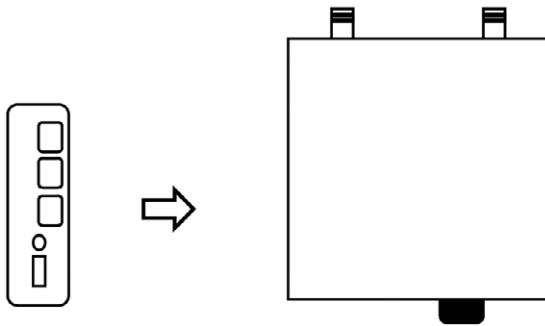

- 2.4.1 Turn off the RX power supply. The RX power supply must be turned off otherwise it will damage the RX's memory IC (EEPROM).
- 2.4.2 Take the magnetic key out of the Copier (OFF).
- 2.4.3 Connect the interface cable from the Copier to the RX.
- 2.4.4 Press and hold the Copier's button that was used to memorize the required functions until the Copier's LED illuminates green (it is abnormal if the Copier's LED illuminates red).
- 2.4.5 Unplug the interface cable.
- 2.4.6 Programming of the receiver is now complete.

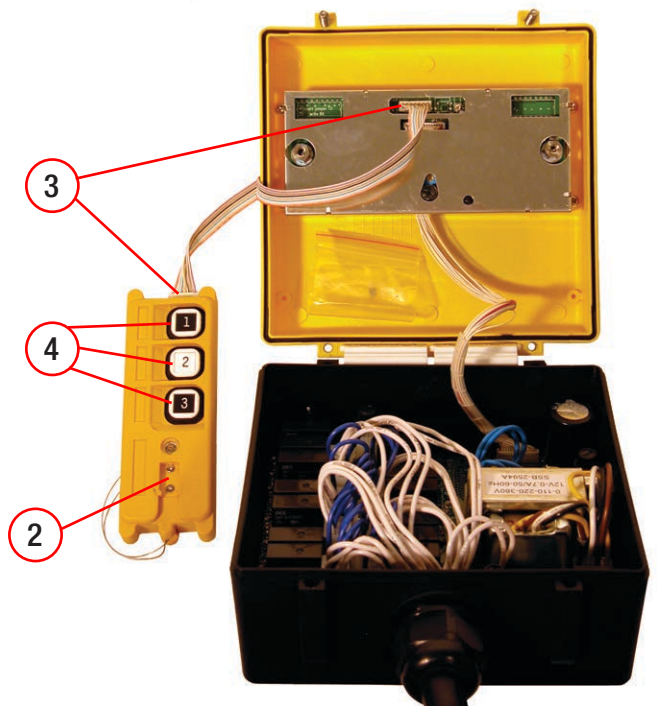

3.0 K3 / K4 Operation

3.1 Procedure for copying / saving program from the TX to copier

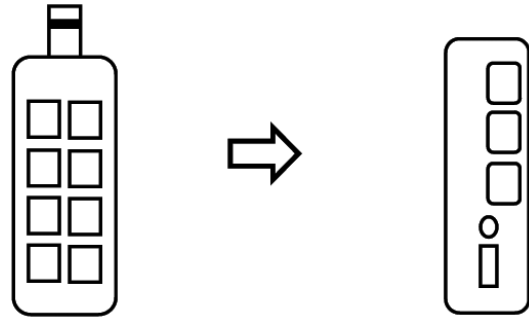
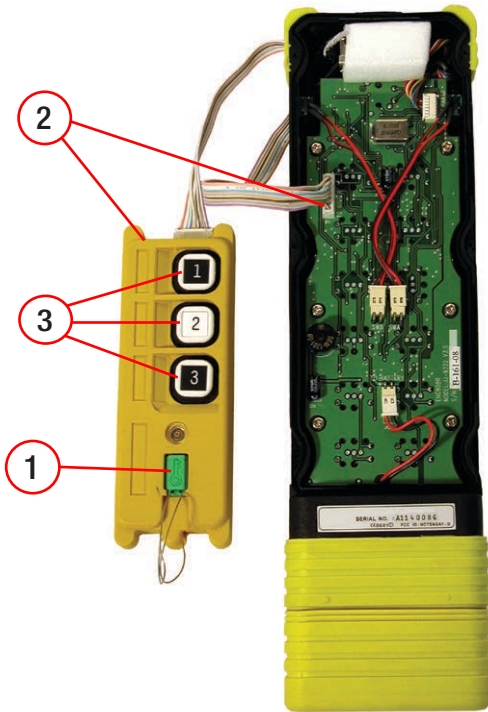

- 3.1.1 Place the Magnetic Key into the Copier (ON).
- 3.1.2 Connect the interface cable from the Copier to the TX.
- 3.1.3 Press and hold one of the Copier's buttons you wish to use for about 5 seconds until the Copier's LED illuminates green (it is abnormal if the Copier's LED illuminates red).
- 3.1.4 Unplug the interface cable.

3.2 Procedure for copying / saving program from the RX to the copier

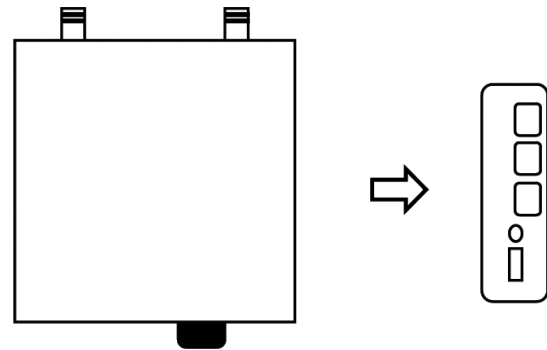
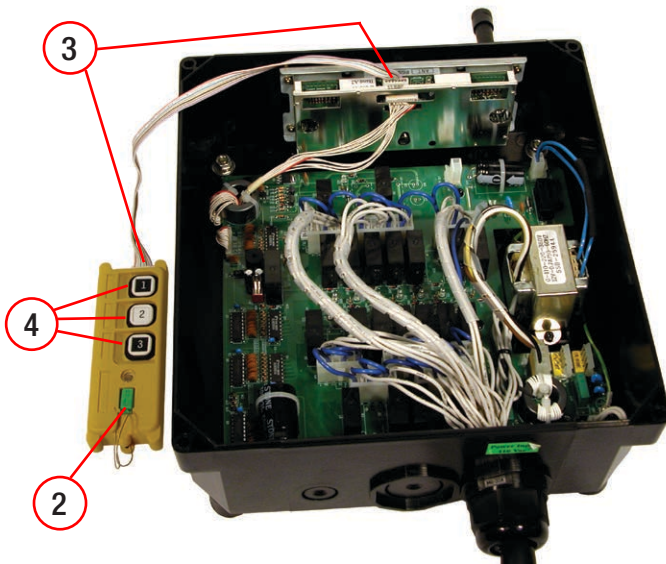

- 3.2.1 Turn off the RX power supply. The RX power supply must be turned off otherwise it will damage the RX's memory IC (EEPROM).
- 3.2.2 Place the Magnetic Key into the Copier (ON).
- 3.2.3 Connect the interface cable from the Copier to the RX.
- 3.2.4 Press and hold one of the Copier's buttons you wish to use, until the Copier's LED illuminates green (it is abnormal if the Copier's LED illuminates red).
- 3.2.5 Unplug the interface cable.

NOTE: After the memorizing is completed, one should remember/record which button was used to memorize the required functions (in order to press the same button to upload the required functions to the same model of radio remote control).

3.0 K3 / K4 Operation

3.3 Procedure for overwriting / replacing program to the TX using the copier

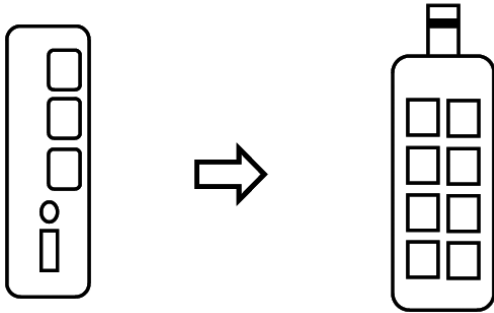

- 3.3.1 Take the Magnetic Key out of the Copier (OFF).
- 3.3.2 Connect the interface cable from the Copier to the TX.
- 3.3.3 Press and hold the Copier's button that was used to memorize the required functions until the Copier's LED illuminates green (it is abnormal if the Copier's LED illuminates red).
- 3.3.4 Unplug the interface cable.
- 3.3.5 Programming of the transmitter is now complete.

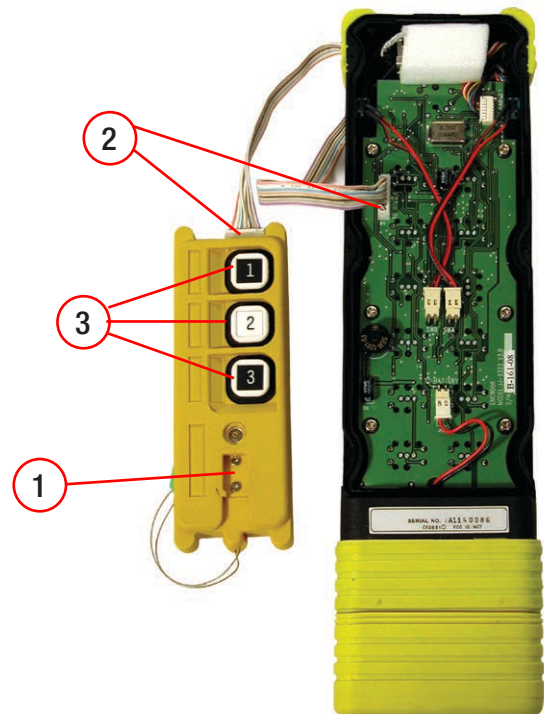

3.4 Procedure for overwriting / replacing program to RX using the copier

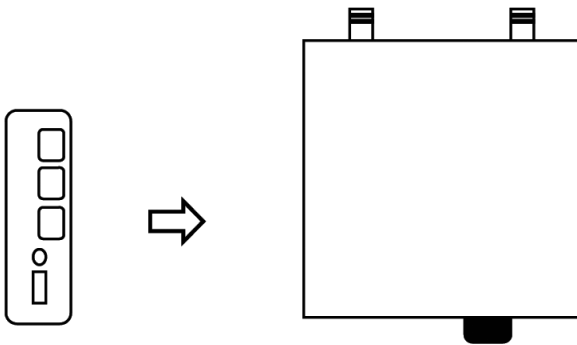

- 3.4.1 Turn off the RX power supply. The RX power supply must be turned off otherwise it will damage the RX's memory IC (EEPROM).
- 3.4.2 Take the magnetic key out of the Copier (OFF).
- 3.4.3 Connect the interface cable from the Copier to the RX.
- 3.4.4 Press and hold the Copier's button that was used to memorize the required functions until the Copier's LED illuminates green (it is abnormal if the Copier's LED illuminates red).
- 3.4.5 Unplug the interface cable.
- 3.4.6 Programming of the receiver is now complete.

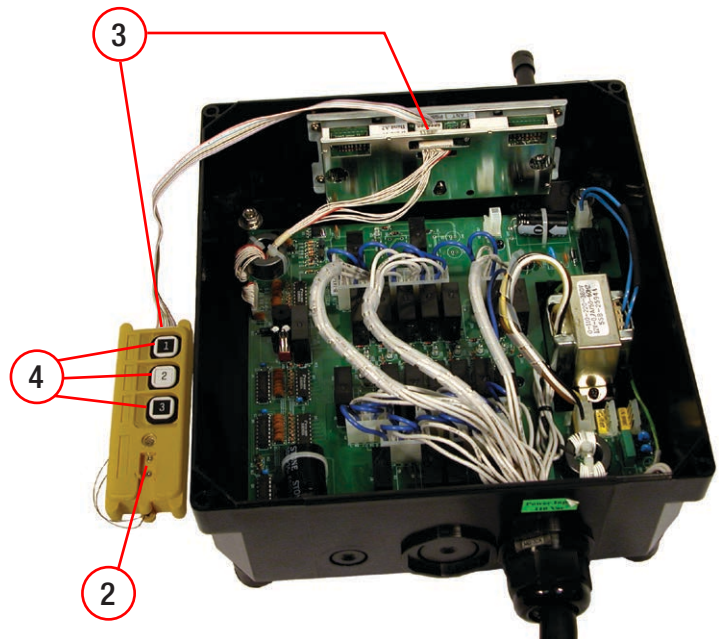

4.0 L10 Operation

4.1 Procedure for copying / saving program from the TX to the copier

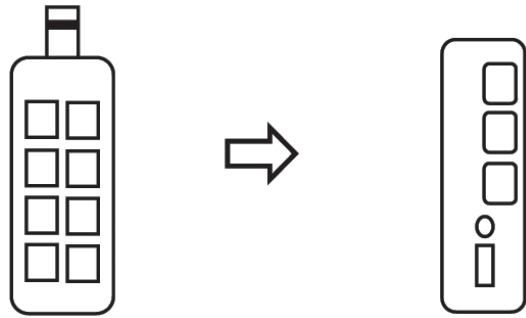
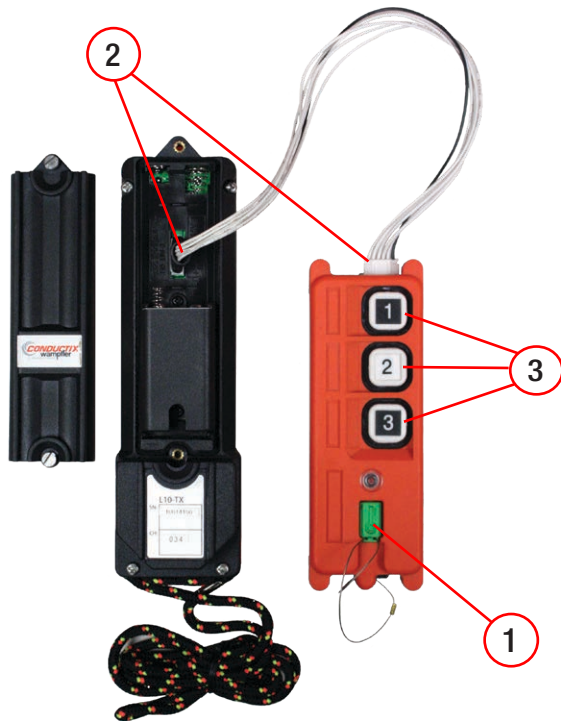

- 4.1.1 Place the Magnetic Key into the Copier (ON).
- 4.1.2 Connect the interface cable from the Copier to the TX.
- 4.1.3 Press and hold one of the Copier's buttons you wish to use for about 5 seconds until the Copier's LED illuminates green (it is abnormal if the Copier's LED illuminates red).
- 4.1.4 Unplug the interface cable.

4.2 Procedure for copying / saving program from the RX to the copier

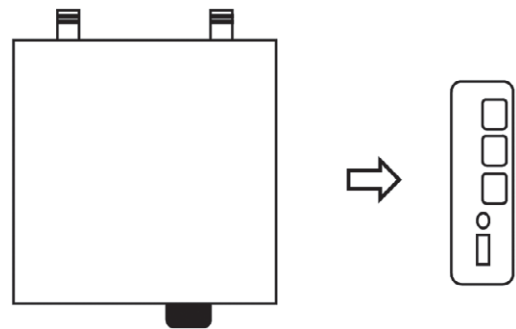
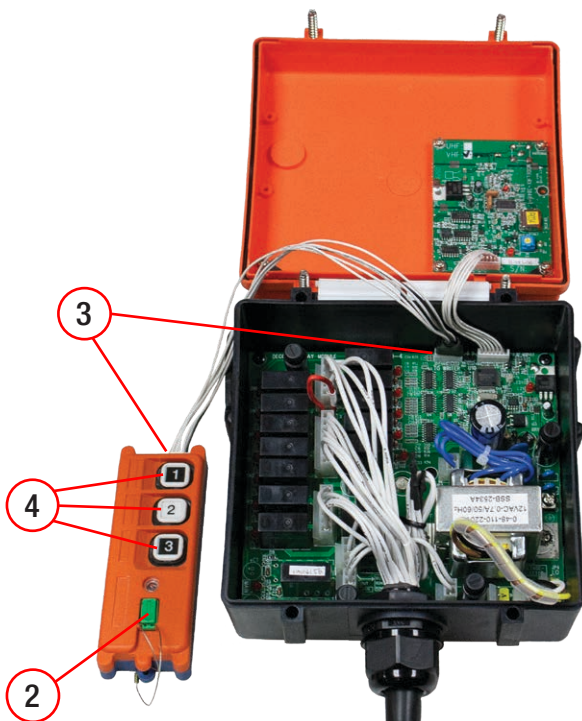

- 4.2.1 Turn off the RX power supply. The RX power supply must be turned off otherwise it will damage the RX's memory IC (EEPROM).
- 4.2.2 Place the Magnetic Key into the Copier (ON).
- 4.2.3 Connect the interface cable from the Copier to the RX.
- 4.2.4 Press and hold one of the Copier's buttons you wish to use, until the Copier's LED illuminates green (it is abnormal if the Copier's LED illuminates red).
- 4.2.5 Unplug the interface cable.

REMARK: After the memorizing is completed, one should remember/record which button was used to memorize the required functions (in order to press the same button to upload the required functions to the same model of radio remote control).

4.0 L10 Operation

4.3 Procedure for overwriting / replacing program to TX using the copier

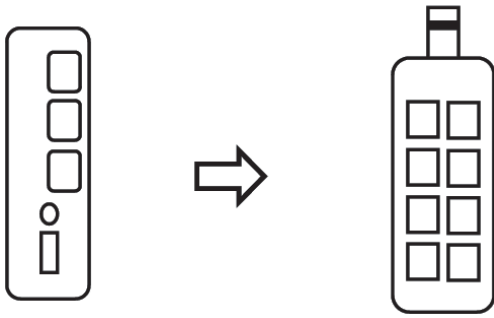

- 4.3.1 Take the Magnetic Key out of the Copier (OFF).
- 4.3.2 Connect the interface cable from the Copier to the TX.
- 4.3.3 Press and hold the Copier's button that was used to memorize the required functions until the Copier's LED illuminates green (it is abnormal if the Copier's LED illuminates red).
- 4.3.4 Unplug the interface cable.
- 4.3.5 Programming of the transmitter is now complete.

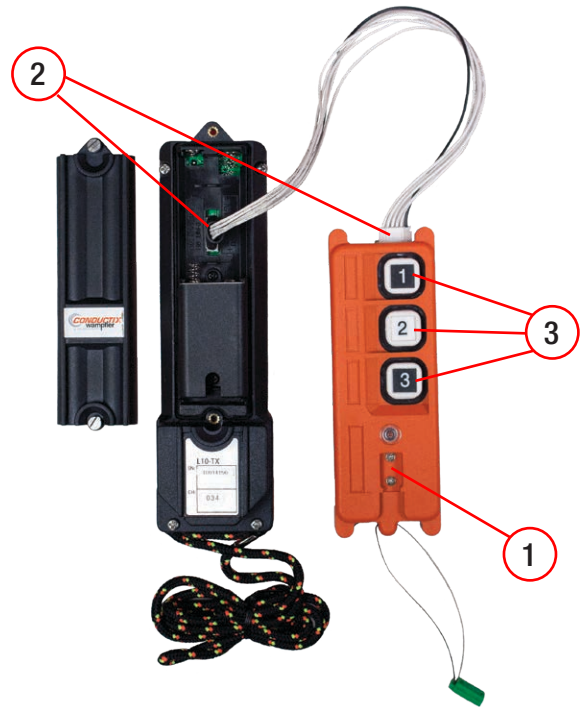

4.4 Procedure for overwriting / replacing program to RX using the copier

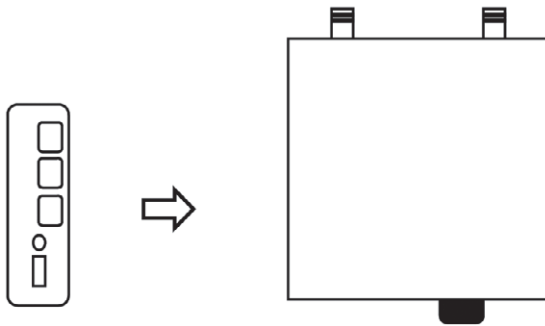

- 4.4.1 Turn off the RX power supply. The RX power supply must be turned off otherwise it will damage the RX's memory IC (EEPROM).
- 4.4.2 Take the magnetic key out of the Copier (OFF).
- 4.4.3 Connect the interface cable from the Copier to the RX.
- 4.4.4 Press and hold the Copier's button that was used to memorize the required functions until the Copier's LED illuminates green (it is abnormal if the Copier's LED illuminates red).
- 4.4.5 Unplug the interface cable.
- 4.4.6 Programming of the receiver is now complete.

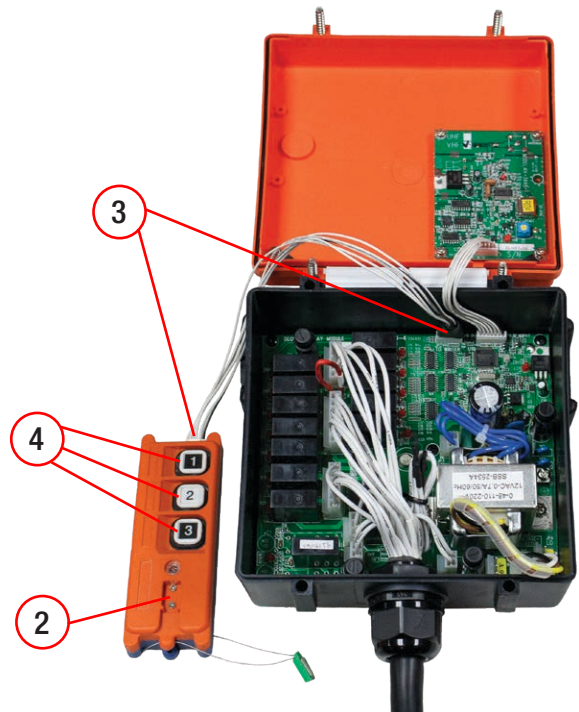

5.0 L12 Operation

5.1 Procedure for copying / saving program from the TX to copier

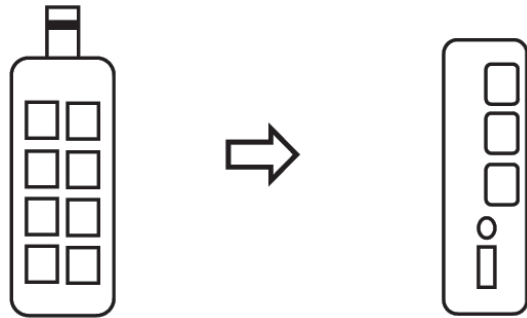
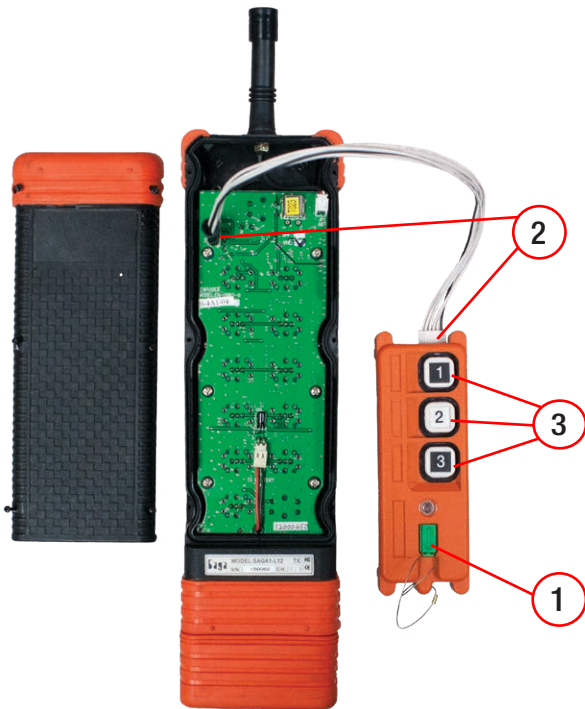

- 5.1.1 Place the Magnetic Key into the Copier (ON).
- 5.1.2 Connect the interface cable from the Copier to the TX.
- 5.1.3 Press and hold one of the Copier's buttons you wish to use for about 5 seconds until the Copier's LED illuminates green (it is abnormal if the Copier's LED illuminates red).
- 5.1.4 Unplug the interface cable.

5.2 Procedure for copying / saving program from the RX to the copier

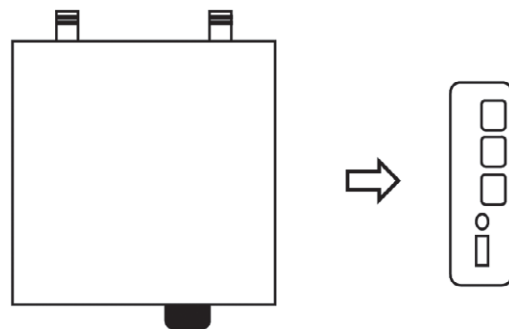
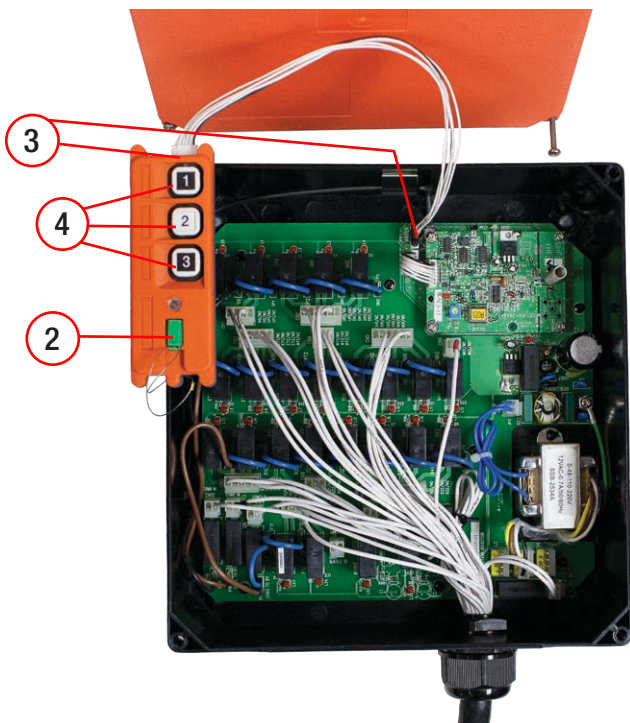

- 5.2.1 Turn off the RX power supply. The RX power supply must be turned off otherwise it will damage the RX's memory IC (EEPROM).
- 5.2.2 Place the Magnetic Key into the Copier (ON).
- 5.2.3 Connect the interface cable from the Copier to the RX.
- 5.2.4 Press and hold one of the Copier's buttons you wish to use, until the Copier's LED illuminates green (it is abnormal if the Copier's LED illuminates red).
- 5.2.5 Unplug the interface cable.

NOTE: After the memorizing is completed, one should remember/record which button was used to memorize the required functions (in order to press the same button to upload the required functions to the same model of radio remote control).

5.0 L12 Operation

5.3 Procedure for overwriting / replacing program to the TX using the copier

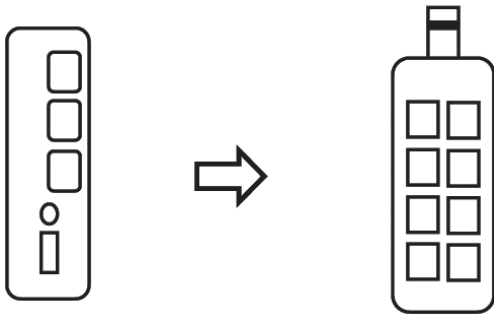

- 5.3.1 Take the Magnetic Key out of the Copier (OFF).
- 5.3.2 Connect the interface cable from the Copier to the TX.
- 5.3.3 Press and hold the Copier's button that was used to memorize the required functions until the Copier's LED illuminates green (it is abnormal if the Copier's LED illuminates red).
- 5.3.4 Unplug the interface cable.
- 5.3.5 Programming of the transmitter is now complete.

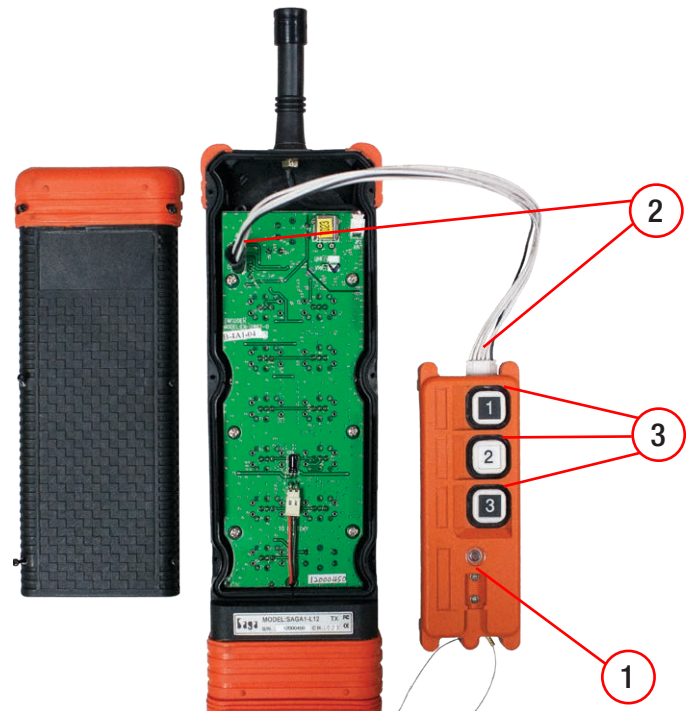

5.4 Procedure for overwriting / replacing program to RX using the copier

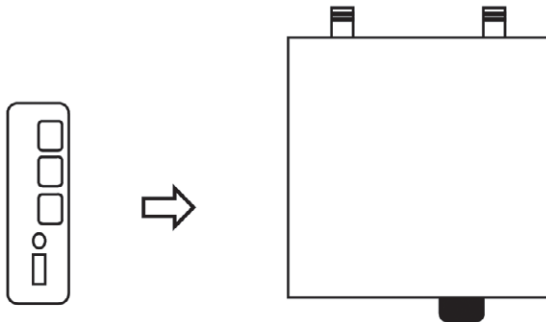

- 5.4.1 Turn off the RX power supply. The RX power supply must be turned off otherwise it will damage the RX's memory IC (EEPROM).
- 5.4.2 Take the magnetic key out of the Copier (OFF).
- 5.4.3 Connect the interface cable from the Copier to the RX.
- 5.4.4 Press and hold the Copier's button that was used to memorize the required functions until the Copier's LED illuminates green (it is abnormal if the Copier's LED illuminates red).
- 5.4.5 Unplug the interface cable.
- 5.4.6 Programming of the receiver is now complete.

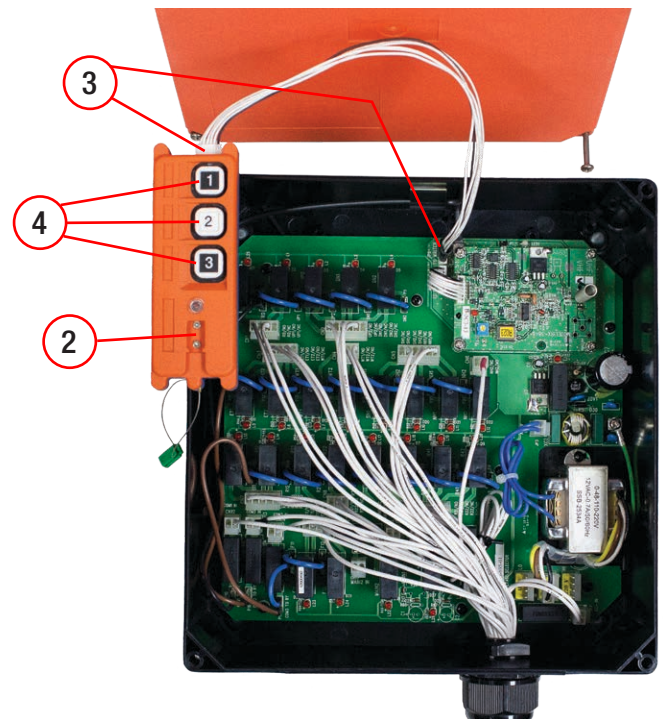

6.0 L40 Series Operation

6.1 Procedure for copying / saving program from the TX to the copier

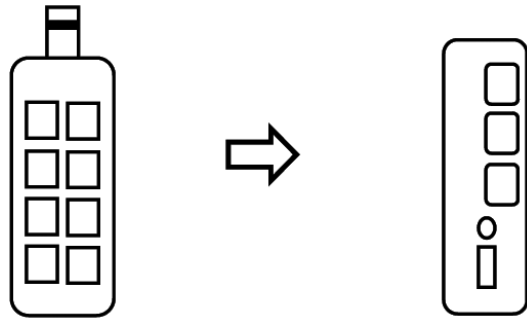
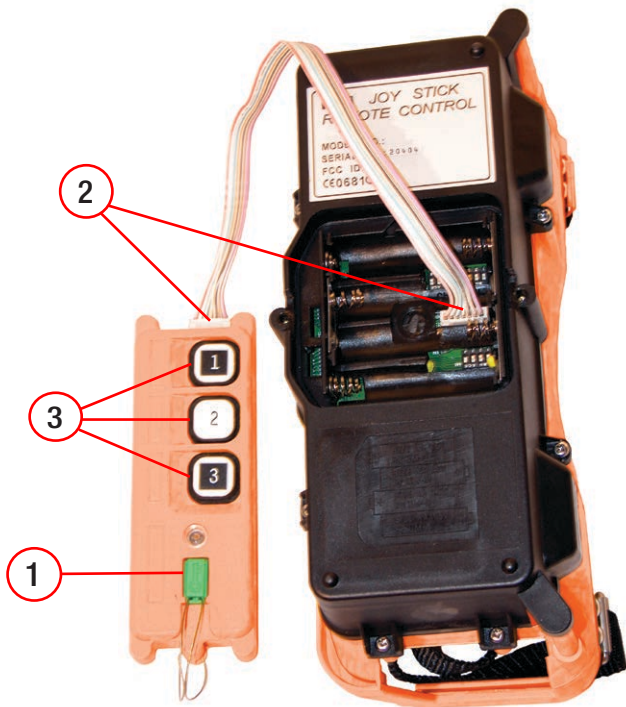

- 6.1.1 Place the Magnetic Key into the Copier (ON).
- 6.1.2 Connect the interface cable from the Copier to the TX.
- 6.1.3 Press and hold one of the Copier's buttons you wish to use for about 20 seconds until the Copier's LED illuminates green (it is abnormal if the Copier's LED illuminates red).
- 6.1.4 Unplug the interface cable.

6.2 Procedure for copying / saving program from the RX to the copier

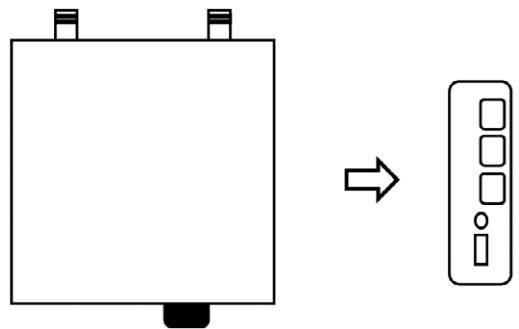
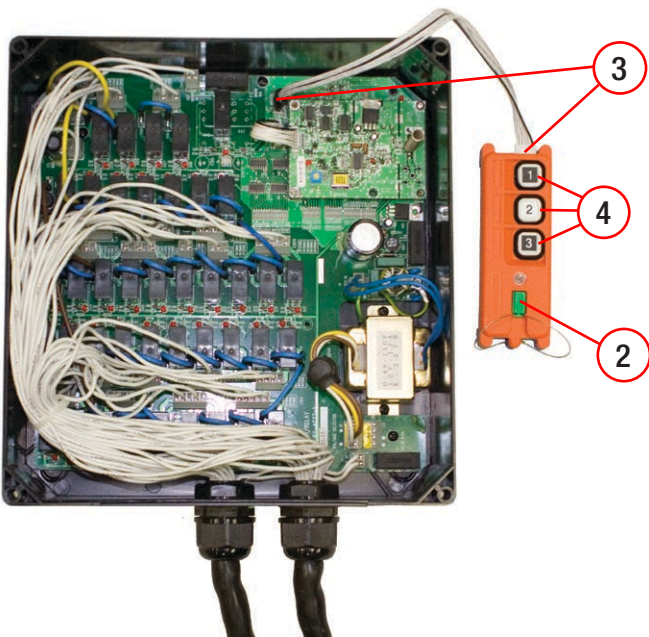

- 6.2.1 Turn off the RX power supply. The RX power supply must be turned off otherwise it will damage the RX's memory IC (EEPROM).
- 6.2.2 Connect the interface cable from the Copier to the RX.
- 6.2.3 Press and hold one of the Copier's buttons wish to use, for about 20 seconds, until the Copier's LED illuminates green (it is abnormal if the Copier's LED illuminates red).
- 6.2.4 Unplug the interface cable.

6.0 L40 Series Operation

6.3 Procedure for overwriting / replacing program to the TX using copier

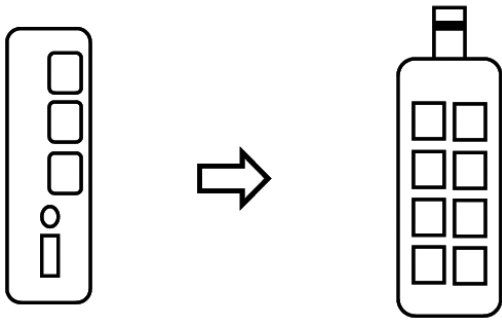

- 6.3.1 Take the Magnetic Key out of the Copier (OFF).
- 6.3.2 Connect the interface cable from the Copier to the TX.
- 6.3.3 Press and hold the Copier's button (for approx. 20 seconds) that was used to memorize the required functions until the Copier's LED illuminates green (it is abnormal if the Copier's LED illuminates red).
- 6.3.4 Unplug the interface cable.
- 6.3.5 Programming of the transmitter is now complete.

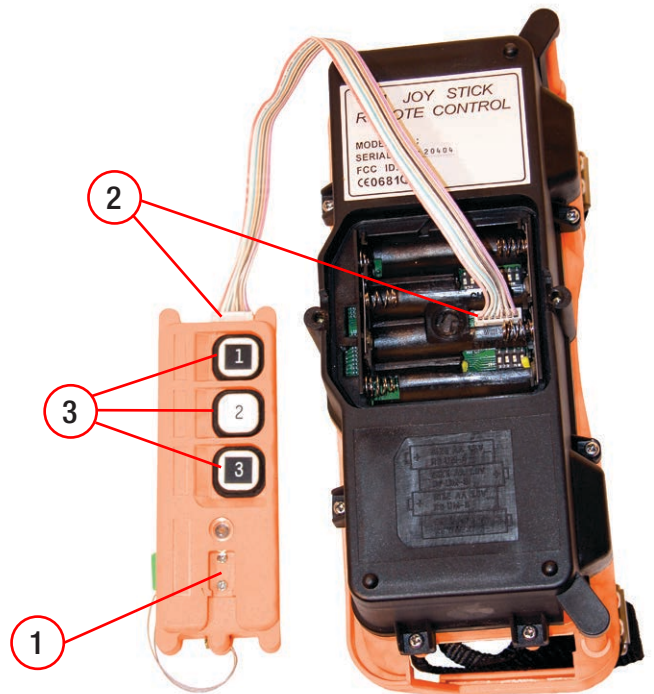

6.4 Procedure for overwriting / replacing program to the RX using the copier

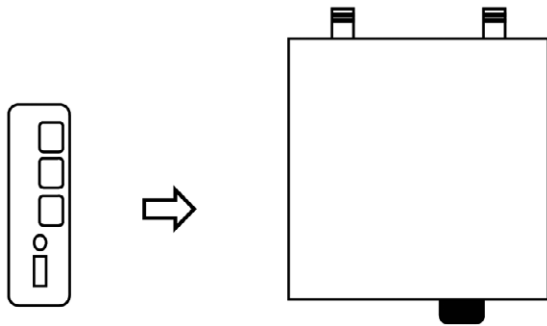

- 6.4.1 Turn off the RX power supply. The RX power supply must be turned off otherwise it will damage the RX's memory IC (EEPROM).
- 6.4.2 Take the magnetic key out of the Copier (OFF).
- 6.4.3 Connect the interface cable from the Copier to the RX.
- 6.4.4 Press and hold the Copier's button (for approx. 20 seconds) that was used to memorize the required functions until the Copier's LED illuminates green (it is abnormal if the Copier's LED illuminates red).
- 6.4.5 Unplug the interface cable.
- 6.4.6 Programming of the receiver is now complete.

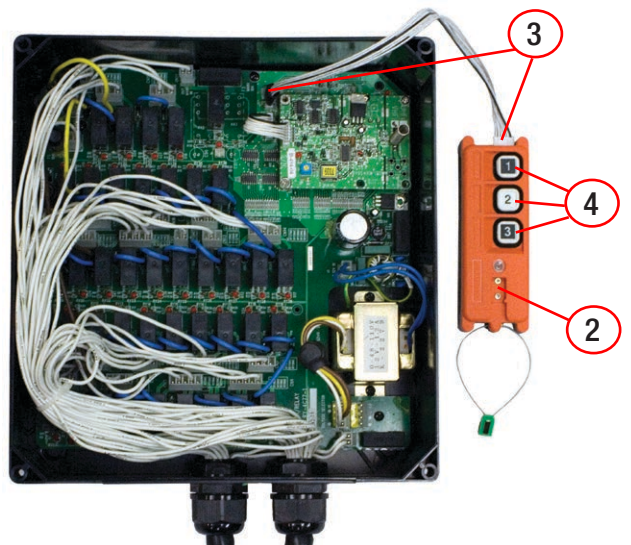

7.0 Protean Series Operation

7.1 Procedure for copying / saving program from the TX to the copier

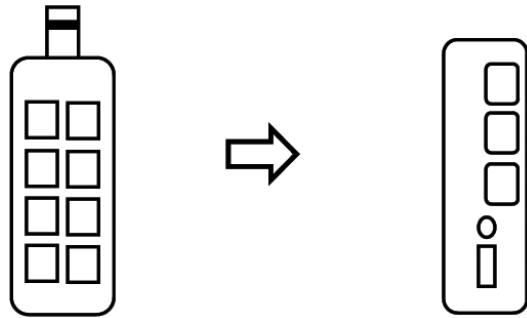
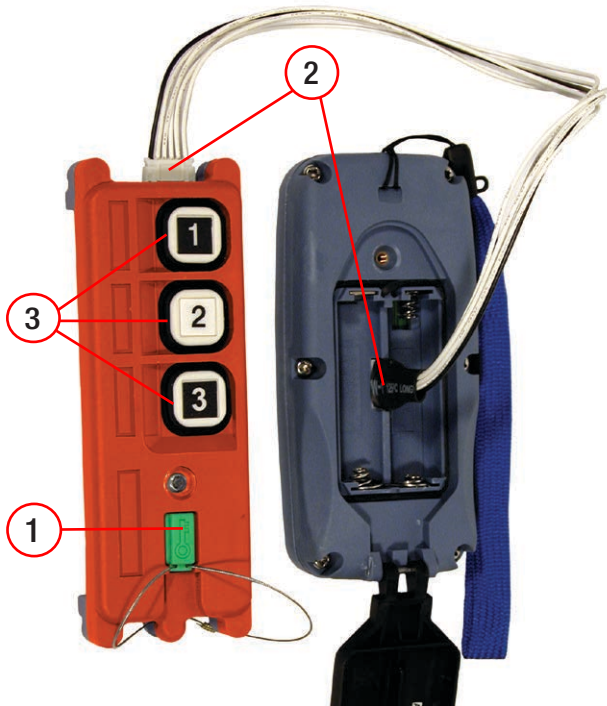

- 7.1.1 Place the Magnetic Key into the Copier (ON).
- 7.1.2 Connect the interface cable from the Copier to the TX.
- 7.1.3 Press and hold one of the Copier's buttons you wish to use for about 5 seconds until the Copier's LED illuminates green (it is abnormal if the Copier's LED illuminates red).
- 7.1.4 Unplug the interface cable.

7.2 Procedure for copying / saving program from the RX to the copier

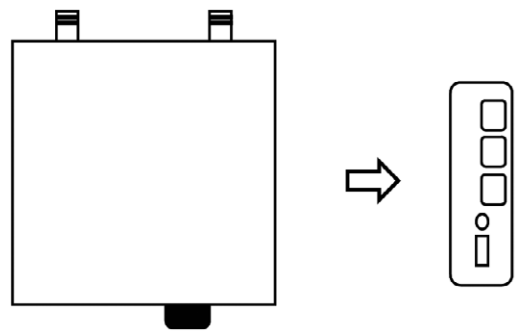
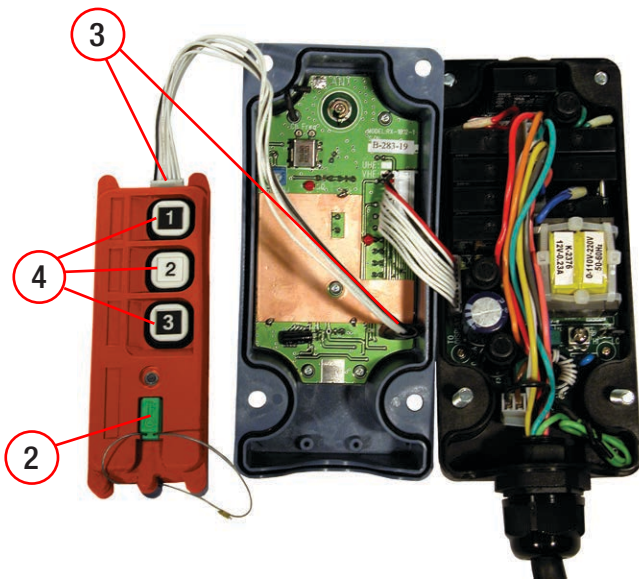

- 7.2.1 Turn off the RX power supply. The RX power supply must be turned off otherwise it will damage the RX's memory IC (EEPROM).
- 7.2.2 Place the Magnetic Key into the Copier (ON).
- 7.2.3 Connect the interface cable from the Copier to the RX.
- 7.2.4 Press and hold one of the Copier's buttons you wish to use, until the Copier's LED illuminates green (it is abnormal if the Copier's LED illuminates red).
- 7.2.5 Unplug the interface cable.

REMARK: After the memorizing is completed, one should remember/record which button was used to memorize the required functions (in order to press the same button to upload the required function to the same model of radio remote control).

7.0 Protean Series Operation

7.3 Procedure for overwriting / replacing program to the TX using copier

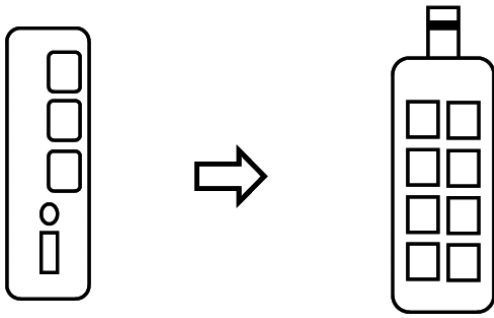

- 7.3.1 Take the Magnetic Key out of the Copier (OFF).
- 7.3.2 Connect the interface cable from the Copier to the TX.
- 7.3.3 Press and hold the Copier's button that was used to memorize the required functions until the Copier's LED illuminates green (it is abnormal if the Copier's LED illuminates red).
- 7.3.4 Unplug the interface cable.
- 7.3.5 Programming of the transmitter is now complete.

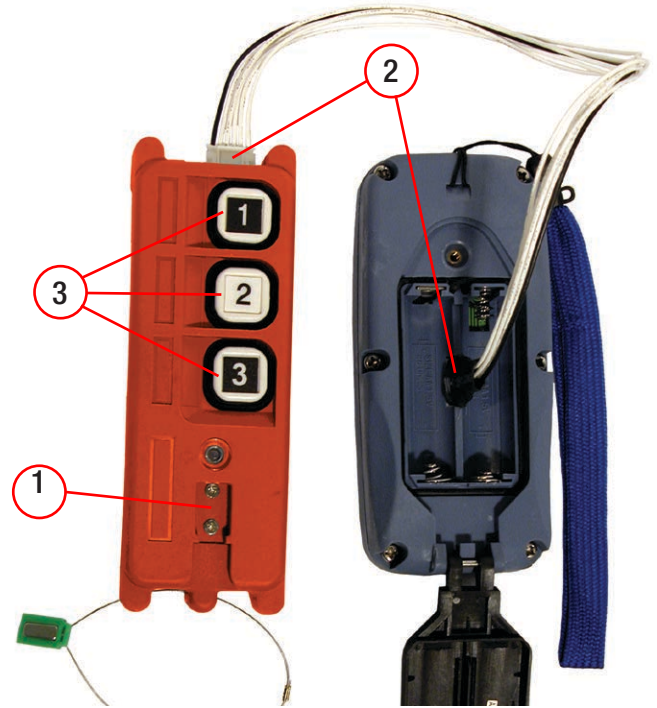

7.4 Procedure for overwriting / replacing program to the RX using the copier

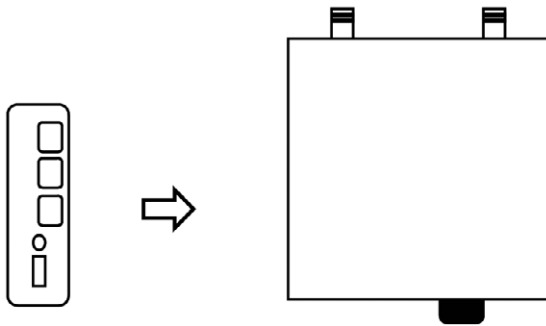

- 7.4.1 Turn off the RX power supply. The RX power supply must be turned off otherwise it will damage the RX's memory IC (EEPROM).
- 7.4.2 Take the magnetic key out of the Copier (OFF).
- 7.4.3 Connect the interface cable from the Copier to the RX.
- 7.4.4 Press and hold the Copier's button that was used to memorize the required functions until the Copier's LED illuminates green (it is abnormal if the Copier's LED illuminates red).
- 7.4.5 Unplug the interface cable.
- 7.4.6 Programming of the receiver is now complete.

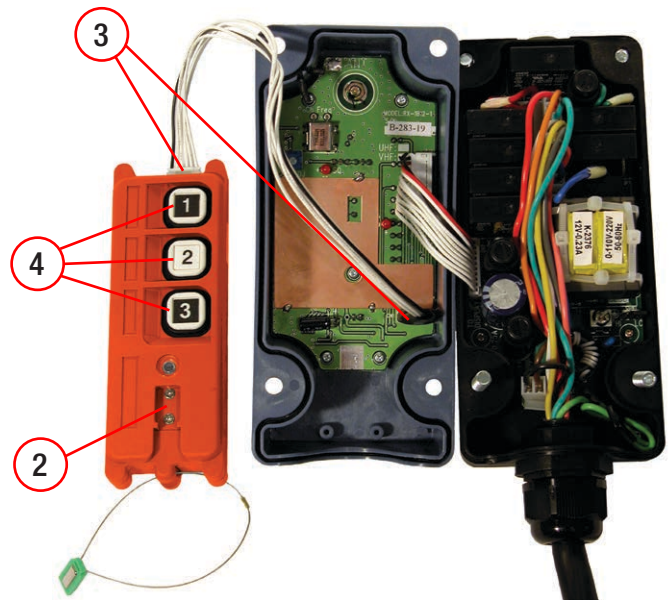

www.conductix.us

USA / LATIN AMERICA

10102 F Street
Omaha, NE 68127

Customer Support
Phone +1-800-521-4888

Phone +1-402-339-9300
Fax +1-402-339-9627

info.us@conductix.com
latinamerica@conductix.com

CANADA

1435 Norjohn Court
Unit 5
Burlington, ON L7L 0E6

Customer Support
Phone +1-800-667-2487

info.ca@conductix.com

MÉXICO

Calle Treviño 983-C
Zona Centro
Apodaca, NL México 66600

Customer Support
Phone (+52 81) 1090 9519
(+52 81) 1090 9025
(+52 81) 1090 9013

Fax (+52 81) 1090 9014

info.mx@conductix.com

BRAZIL

Rua Dois, 493
Itu, São Paulo, Brasil
CEP: 13312-820

Customer Support
Phone (+55 11) 4813 7330

Fax (+55 11) 4813 7330

info.br@conductix.com

Contact us for our Global Sales Offices

